

SUBMITTAL DOCUMENTS

FOR

ROOF REPLACEMENT

OF

WeatherWeld - A Division of Liquiform Technologies Bid Package I-1B-16-30-A

Prepared For:

email:
phone:

Removal of the existing roof and any roof deck insulation which may be present. Install Polyiso Insulation, DensDeck, WeatherWeld 1B-16-30 system, and Title 24 compliant reflective roof coating.

Date Prepared:

Existing Roof: Approved Roof Deck

Proposed System: I-1B-16-30-A

Design Considerations:

- 40 Year NDL Warranty
- UL Class A
- FM 1-90 (45 psf) Design Pressure
- Title 24 Compliant Reflective Surface Coating

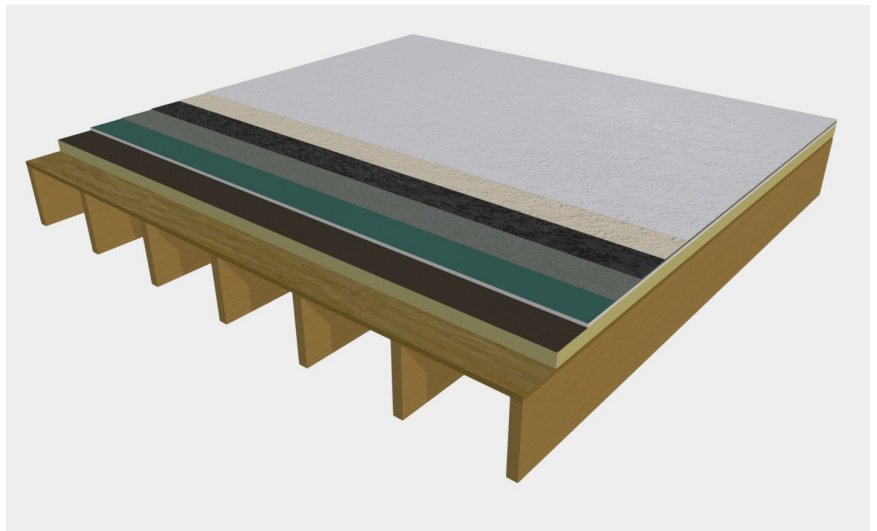

*Measurements are from aerial survey and do not include roof slope or parapet walls.
This image is for reference only and not to be used for estimation purposes.*

Provided By:

WEATHERWELD™

WeatherWeld - A Division of Liquiform Technologies Inc.
9757 7th St. #803 Rancho Cucamonga, CA 91730
(888) 440-3224
info@weatherweld.com

Technical Contact: Kody Berry

Phone: (909)-477-1842

Email: kody@weatherweld.com

Design Contact: Robert Weygant

Phone: (973)-919-1980

Email: robert@weatherweld.com

Scan For More Info



Scope of Work

Overview

PROJECT LOCATION:	
WEATHERWELD SYSTEM:	I-1B-16-30-A
EXISTING CONDITIONS:	Approved Roof Deck
SYSTEM OVERVIEW:	Removal of the existing roof and any roof deck insulation which may be present. Install Polyiso Insulation, DensDeck, WeatherWeld 1B-16-30 system, and Title 24 compliant reflective roof coating.
WARRANTY:	40 Years
FIRE RATING:	UL Class A
DESIGN PRESSURE:	45 PSF (FM 1-90)
CLIMATE ZONE:	TBD
THERMAL REQUIREMENT:	Per Climate Zone

Materials

WEATHERWELD MEMBRANE

WeatherWeld Emulsion:	30 Gallons / 100 square feet
WeatherWeld Fiberglass:	16 Lbs. / 100 square feet
Acrylic Basecoat:	1.5 Gallons / 100 square feet
Acrylic Topcoat:	1.5 Gallons / 100 square feet
Anchor/Base Sheet:	G2 Base Sheet

INSULATION

Insulation:	Polyiso
Substrate / Cover Board:	DensDeck Prime

ACCESSORIES

Polyurethane Sealant:	Where Applicable
Asphalt Primer:	Where Applicable
Asphalt Adhesive:	Where Applicable
Self-Adhering Membrane:	Where Applicable
Pre-Formed Flashings:	Where Applicable

Detailing Conditions

Conditions listed are common rooftop details which may or may not be present on the project.

Flat Edge Termination Flashings	Roof Drain Flashings	Rooftop Duct Encapsulation
Raised Edge Edge Flashings	Pipe Penetration Flashings	Skylight Flashings
Gutter Edge Flashings	Mechanical Equipment Curbs	Roof Hatch Flashings
Roof Transition Flashings	Sheetmetal Storm Collars	Smoke Vent Flashings
Wall Termination Flashings	Pitch Pocket Flashing	Misc. Sheetmetal Flashings
Parapet Coping Caps	Expansion / Control Joint Flashing	

General Information

1.0 PROCEDURE

- A. Remove existing roof(s) and insulation to entirely expose the roof deck.
- B. Repair any damage to the substrate, remove any exposed or erupted fasteners, and clean thoroughly in preparation to receive the roof system.
- C. Install Insulation with approved adhesive and/or fasteners.
- D. Install cover board with approved adhesive.
- E. Install base sheet with approved adhesive.
- F. Apply Seamless roof membrane materials to provide a watertight roof assembly that meets WeatherWeld warranty requirements. Encapsulate entire roof area.
- G. Install Flashings and Accessories.
- H. Install Walkway pads (where applicable).
- I. Apply Anti-Skid Traffic Coating (where applicable).

2.0 ADMINISTRATION

- A. Refer to local laws and building code for thermal value requirements, wind uplift, and other requirements.
- B. Refer to Manufacturer installation manual, detail drawings, and specific industry guidelines for good work practice procedures.
- C. Follow all recommendations referenced in the current edition of NRCA roofing and Waterproofing Manual.
- D. Wind Uplift Rating Required: I-90
- E. Fire Rating: UL Class A

3.0 ROOF INSPECTION

- A. Provide written documentation to owner to replace wet/damaged roofing materials or decking.
- B. Installer is responsible to ensure no ponding water exists after 48 hours after precipitation.

4.0 PROTECTION OF WORK

- A. Protect all areas from material spills and overspray with appropriate masking.
- B. Protect adjacent areas from vehicle or equipment staging damage.
- C. All areas not specified for roofing material installation must be clean and free of material drips or overspray before project is considered complete.

5.0 GENERAL REQUIREMENTS AND BEST PRACTICES

- A. Ensure all surfaces are clean, compatible, dry, free from debris and sharp projections, dirt, grease, etc. before installing roofing materials.
- B. Install asphalt primer to facilitate proper adhesion at flashings, walls, and other rooftop components.
- C. Ensure roof is washed between steps to ensure adequate adhesion.
- D. Contractor is responsible to ensure no ponding water exists when the project is complete.

Substrate Preparation

1.0 GENERAL:

- A. All necessary repairs to field and flashings must be performed according to accepted roof construction best practices.
- B. Repairs include but are not limited to the removal and replacement of all wet insulation, damaged roof decking and/or structural members, and/or defective materials.
- C. Existing conditions may be identified through a moisture detection survey such as an infrared scan.

2.0 PROCEDURE:

- A. Remove down to the roof deck, all roofing and insulation materials.
- B. Remove all damaged roof flashings at curbs and parapet walls.
- C. Remove all existing flashings at roof drains and penetrations.
- D. Where roof removal / demolition creates inconsistencies in the roof surface, fill any low spots with like materials to create a smooth, even surface for application of new roof membranes.
- E. Install new wood nailers as necessary.
- F. Repair all defects such as deteriorated roof decks, verify that existing conditions meet the following requirements:
 - 1. Remove all loose dirt and foreign debris from the roof surface. Do not damage roof materials in cleaning process.
 - 2. Clean and seal all parapet walls, gutters, and coping caps, and repair any damaged metal where necessary. Seal watertight all fasteners, pipes, drains, vents, joints, and penetrations where water could enter the building envelope.
 - 3. Confirm local water run-off ordinances and restrictions prior to cleaning roof. Clean the entire roof surface by removing all dirt, algae, mold, moss, paint, oil, talc, rust, or other foreign substance. Use a bio-degradable cleaner when necessary and warm water. Scrub heavily soiled areas with a brush. Power wash roof thoroughly with an industrial surface cleaner equipped with one-piece balanced spray rotating jets for streak free close contact cleaning. Rinse with fresh water to completely remove all residuals. Allow roof to dry thoroughly before continuing.

Roof System Installation

1.0 INSULATION

- A. Install base layer of insulation with approved adhesive or fasteners.
- B. Install subsequent layers of insulation with approved adhesive.
- C. Where multiple layers of insulation are to be installed, they may be simultaneously attached.
- D. Install cover board with approved adhesive.

2.0 BASE SHEET

- A. Install base sheet with a minimum 4 inch (103mm) head lap and minimum 6 inch (152mm) side lap.
- B. Extend base sheet beyond cant strips and terminate at the top of all base flashings.
- C. Attach base sheet with adhesive or fasteners as specified by the manufacturer for each type of substrate found on the project.

3.0 WEATHERWELD SEAMLESS COMPOSITE MEMBRANE

- A. Coverage Rates:
 - 1. 30 Gallons / 100 square feet of WeatherWeld Emulsion.
 - 2. 16 Lbs. / 100 square feet of Weatherweld Fiberglass Roving.
- B. Installation
 - 1. Encapsulate entire roof area.
 - 2. Extend composite applications to top of outside edges of parapet walls / terminations / equipment / counter flashings / pipe penetration flashings.
 - 3. Allow to cure for 10 days.

4.0 REFLECTIVE COATING SYSTEM

- A. Coverage Rates:
 - 1. 1.5 Gallons / 100 square feet of WeatherWeld Acrylic Base-Coat.
 - 2. 1.5 Gallons / 100 square feet of WeatherWeld Acrylic Top-Coat (Title 24 Compliant).
- B. Installation
 - 1. Apply reflective coating to all surfaces covered with Seamless Composite Membrane.
 - 2. Install Basecoat and allow to cure for 2 days.
 - 3. Install Topcoat and allow to cure for 2 days.

5.0 PROTECTION

- A. Protect all areas from material spills and overspray with appropriate masking.
- B. Protect adjacent areas from vehicle or equipment staging damage.
- C. All areas not specified for roofing material installation must be clean and free of material drips or overspray before project is considered complete.

Flashing Considerations

1.0 GENERAL

- A. All rooftop flashings except sheetmetal counter-flashings shall be encapsulated with 250 mills DFT of WeatherWeld membrane when complete.
- B. All flashing heights must be Min. 8". Contact WeatherWeld rep for guidance on existing flashings less than the Min. flashing height requirement.
- C. Wind uplift attachment: I-90 Install flashings with attachment systems to meet wind uplift requirement.
- D. All coping and edge termination flashings must be cleat attached.
- E. Perimeter flashings must be attached by continuous cleat where applicable.
- F. All terminations will be counter flashed with sheetmetal by min. 3" including exterior walls.
- G. Sheetmetal must be min 24 Ga. Galvanized or bonderized (if match painted. Owner chooses color.) Sheetmetal coping may be Kynar coated.
- H. Existing flashings in serviceable condition may be reused.
- I. Clean flashings to bare metal.
- J. Edge flashings and scuppers must be removed and replaced with new.
- K. Un-flashed or deteriorated flashings at penetrations must have new flashing installed.
- L. Prime all flanges with asphalt primer at rate of 1 Gal per square.
- M. Install continuous strip of Self-Adhering Membrane under all perimeter flashings extending 2 inches over edge.
- N. Install continuous strip of Self-Adhering Membrane at sheetmetal flanges min. 2 inches onto flange extending min. 6 inches onto roof.
- O. Sheetmetal extension skirt is to be used where counterflashing cannot be used, or existing flashing is too tight to extend WeatherWeld applications.

2.0 BASE FLASHINGS (DETAILS 301 - 360)

- A. Install cant strip adhered in adhesive.
- B. Extend base sheet adhered in adhesive extending to top of base flashing.
- C. Install new base flashing with Self adhering membrane where required.
- D. Install new sheetmetal counterflashing at existing reglet.

3.0 WALLS ABOVE BASE FLASHINGS

- A. Install 8" self-adhering membrane strip covering cracks in walls.
- B. Patch cracks in wall with polyurethane sealant.
- C. Install acrylic coating system on stucco walls above Baseflashing. Terminate installation at base of sheetmetal coping.
- D. Extend WeatherWeld application to the outside edge of wall.

4.0 PARAPET WALLS (DETAILS 301 - 305)

- A. Extend WeatherWeld application to the outside edge of wall.
- B. Install new 24 Ga. sheetmetal coping cap. Cleat attached I-90 Rating.

- C. Install Self-Adhering Membrane cover over joints.
- D. Color to chosen by owner.

5.0 SKIRTED COUNTERFLASHINGS (DETAILS 307 & 357)

- A. Extend WeatherWeld application to just below existing counterflashing or coping cap.
- B. Install new 24 Ga. sheetmetal skirt flashing behind the existing flashing. Flashing must extend a minimum of 3 inches below and 1 inch behind the existing counterflashing.
- C. Fasten to meet the specified wind uplift rating.
- D. Color to chosen by owner.

6.0 SHEETMETAL EDGE TERMINATION (DETAIL 201)

- A. Remove existing perimeter edge metal and replace with new sheetmetal edge flashing system.
- B. Color to chosen by owner.

7.0 PIPE AND PENETRATIONS (DETAIL 501)

- A. Flashed Penetrations – If in serviceable condition, reuse existing.
- B. Un-flashed Penetrations - Install new penetration flashings with sheetmetal counterflashing.
- C. Install Sheetmetal storm Collars.

8.0 ROOFTOP EQUIPMENT (DETAIL 402)

- A. Install Tapered Insulation at back side of rooftop equipment to facilitate proper drainage.
- B. Extend base sheet to top of equipment curbs.
- C. Encapsulate with WeatherWeld.

9.0 BUILDING TRANSITIONS

- A. Metal expansion joint- extend WeatherWeld under roofed base flashing. Encapsulate sheetmetal above Baseflashing with WeatherWeld.

10.0 DRAINS (DETAIL 502)

- A. Ensure drains function properly and are free of debris.
- B. Flush mount drains - Replace compression clamps and drain screens.
- C. Scupper drains - Remove and replace with new sheet metal scupper.
- D. Encapsulate drain bowls and flanges with WeatherWeld.

11.0 MOISTURE VENTS

- A. Install one way moisture vents every 1000 sq ft. Encapsulate flange with WeatherWeld. (Insulated roofs only)

12.0 PIPE SUPPORTS

- A. Remove existing wood blocks supporting rooftop pipes.
- B. Install Recycled rubber pipe support block with Galvanized steel strut.
- C. Dura-Block or Equal.

13.0 DESCRIPTION

- A. Remove existing roof and fiberboard, and clean in preparation to receive membrane.

- B. Install specified base sheet to the LWIC concrete deck with fasteners appropriate to the deck type. Attach in accordance with local building codes and wind uplift requirements.
- C. Apply Seamless roof membrane materials to provide a watertight roof assembly that meets WeatherWeld warranty requirements. Encapsulate entire roof area.
- D. Install Flashings and Accessories.
- E. Install Walkway pads.
- F. Apply Anti-Skid Traffic Coating (where applicable).

14.0 ADMINISTRATION

- A. Refer to local laws and building code for thermal value requirements, wind uplift, and other requirements.
- B. Refer to Manufacturer installation manual, detail drawings, and specific industry guidelines for good work practice procedures.
- C. Follow all recommendations referenced in the current edition of NRCA roofing and Waterproofing Manual.
- D. Wind Uplift Rating Required: I-90
- E. Fire Rating: UL Class A

15.0 ROOF INSPECTION

- A. Provide written documentation to owner to replace wet/damaged roofing materials or decking.
- B. Installer is responsible to ensure no ponding water exists after 48 hours after precipitation.

16.0 GENERAL REQUIREMENTS AND BEST PRACTICES

- A. Ensure all surfaces are clean, compatible, dry, free from debris and sharp projections, dirt, grease, etc. before installing roofing materials.
- B. Install asphalt primer to facilitate proper adhesion at flashings, walls, and other rooftop components.
- C. Ensure roof is washed between steps to ensure adequate adhesion.
- D. Contractor is responsible to ensure no ponding water exists when the project is complete.

Detail Drawings

SYSTEM COMPONENTS		
ITEM	DESCRIPTION	VENDOR
8	Cool Roof Top Coat	WeatherWeld
7	Cool Roof Base Coat	WeatherWeld
6	WeatherWeld 16-30 Roof Encapsulation System	WeatherWeld
5	DensDeck Prime Coverboard	GP
4	OlyBond 500 Spot-Shot	OMG Roofing Products
3	Rigid Polyisocyanurate Insulation	Meets ASTM C 1289
9	Existing Wood Roof Deck	(Existing)
10	UL G2 Base Sheet	Meeting ASTM D 4601, Type II

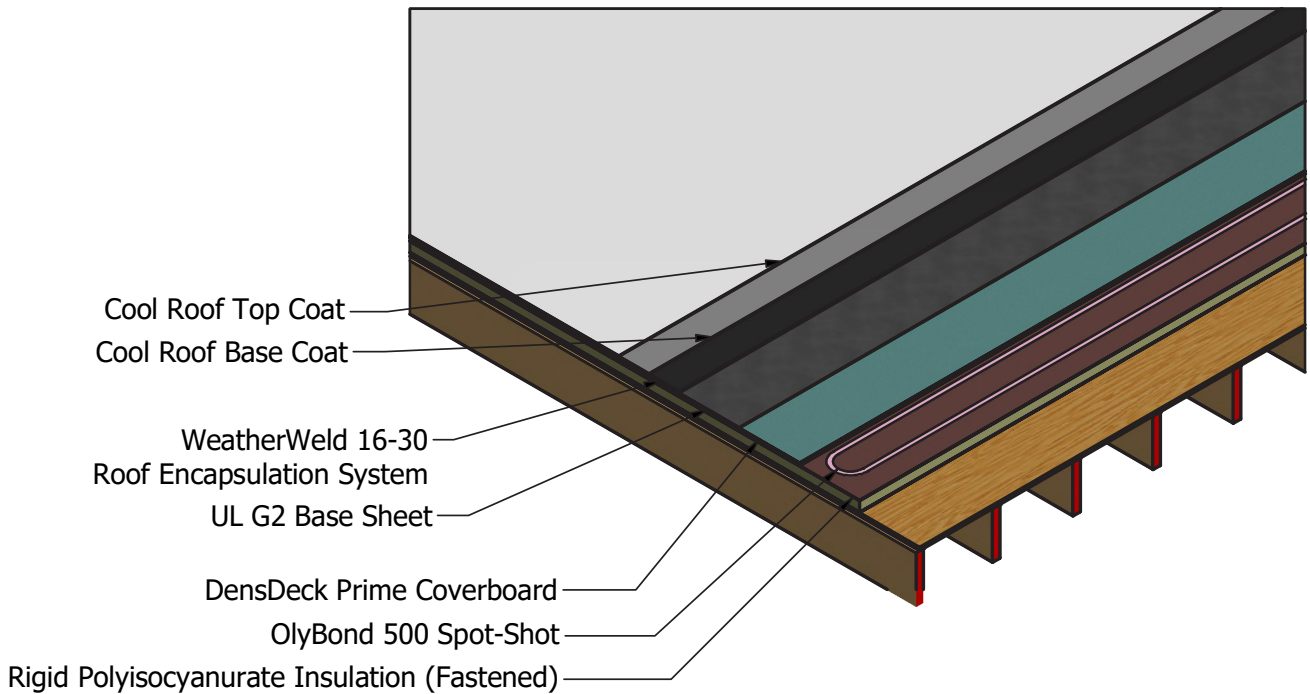

Specifier: R. Weygant	11/10/2023	Detail: System Layout
Approved By: M. Jones		
Roof Inspection By: K. Berry		Project:
Prepared For:		Buildings:
		I-1B-16-30-A
9757 7th St. #803, Rancho Cucamonga, CA 91730 (888) 440-3224 www.weatherweld.com		Scale: 1/2" = 1' - 0"
Plywood Roof Encapsulation w/ WeatherWeld 16-30 System and Cool Roof Coating		Sheet: 2 of 3

System Overview

Deck:	Approved Substrates
Base Sheet:	G2 Base Sheet
Insulation / Cover:	-
Asphalt Emulsion:	30 Gal
Fiberglass Roving:	16 Lbs
Coating:	CA Title 24 Cool Roof Reflective Coating (3 Gal. / 100 Sq.Ft.)

CA TITLE 24 COOL ROOF REFLECTIVE COATING (3 GAL. / 100 SQ.FT.)

I-1B-16-30-A WEATHERWELD APPLICATION
30 GAL / 100 SQ. FT. ASPHALT EMULSION
16 LBS / 100 SQ. FT. FIBERGLASS ROVING

G2 BASE SHEET
DENSDECK PRIME SUBSTRATE BOARD
RIGID POLYISOCYANURATE INSULATION
APPROVED ROOF SUBSTRATE

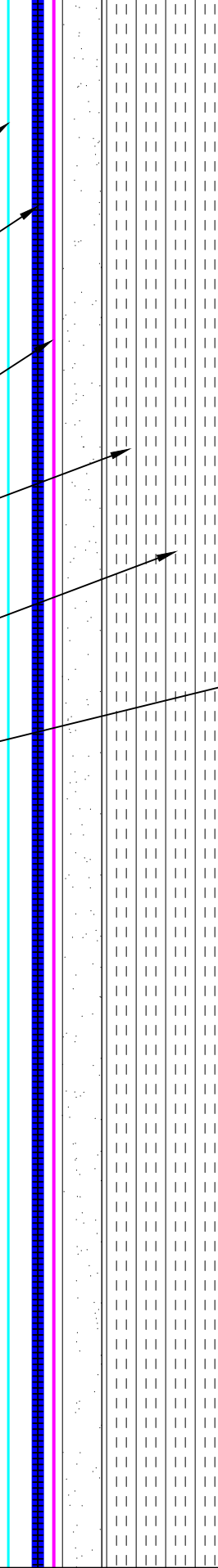

WEATHERWELD
A DIVISION OF LIQUIFORM TECHNOLOGIES, INC.
9757 7th Street, Suite 803
Rancho Cucamonga, CA 91730-5297
(888) 440-3224 | www.weatherweld.com

SYSTEM:
I-1B-16-30-A

Composite Membrane Over
Approved Substrates

SYSTEM OVERVIEW

DETAIL NUMBER:
101

PREPARED FOR:

DRAWN BY:
R. Weygant

APPROVED BY:
M. Jones

PROJECT:

INSTALLED BY:

DATE:
1/24/24

SCALE:

NTS

System Overview

Deck:	Approved Substrates
Base Sheet:	G2 Base Sheet
Insulation / Cover:	-
Asphalt Emulsion:	30 Gal
Fiberglass Roving:	16 Lbs
Coating:	CA Title 24 Cool Roof Reflective Coating (3 Gal. / 100 Sq.Ft.)

CA TITLE 24 COOL ROOF REFLECTIVE COATING (3 GAL. / 100 SQ.FT.)

I-1B-16-30-A WEATHERWELD APPLICATION
30 GAL / 100 SQ. FT. ASPHALT EMULSION
16 LBS / 100 SQ. FT. FIBERGLASS ROVING

G2 BASE SHEET
DENSDECK PRIME SUBSTRATE BOARD
RIGID POLYISOCYANURATE INSULATION
APPROVED ROOF SUBSTRATE

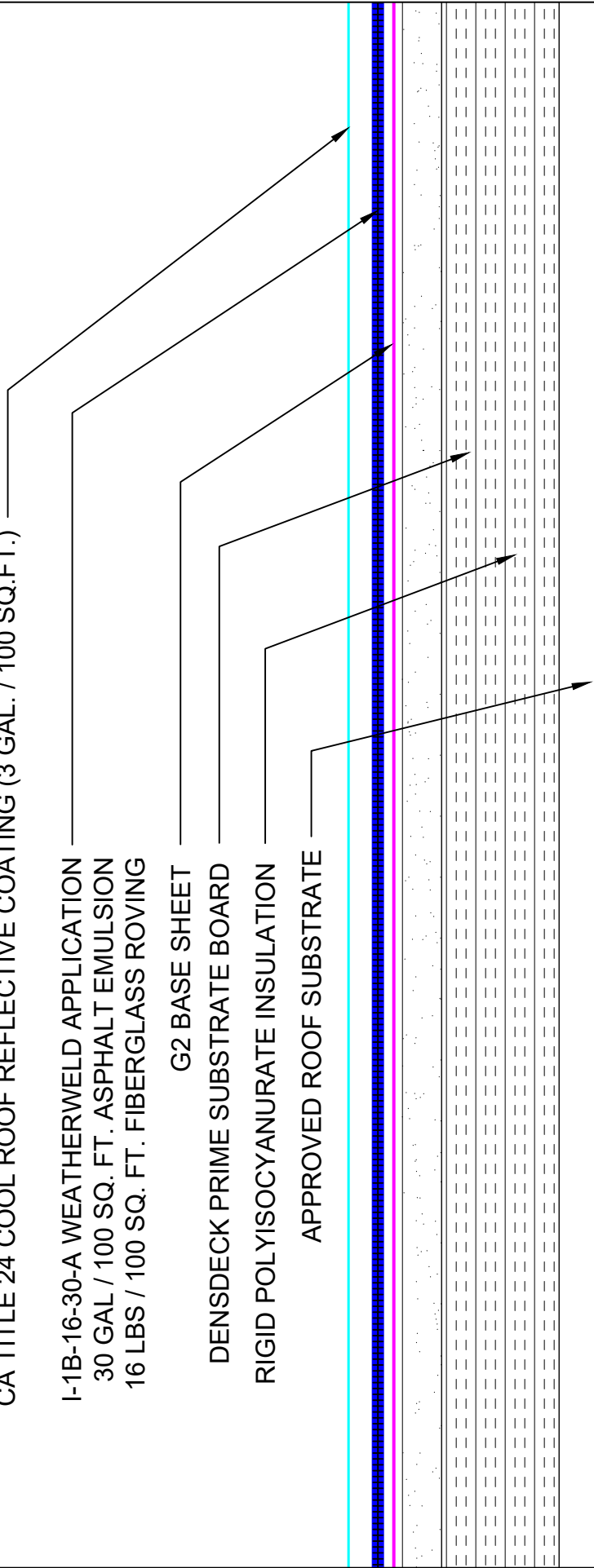

SYSTEM: I-1B-16-30-A Composite Membrane Over Approved Substrates	 A DIVISION OF LIQUIFORM TECHNOLOGIES, INC. 9757 7 th Street, Suite 803 Rancho Cucamonga, CA 91730-5297 (888) 440-3224 www.weatherweld.com	PREPARED FOR: PROJECT: DRAWN BY: R. Weygant APPROVED BY: M. Jones	DATE: 1/24/24 SCALE: NTS
	DRAWING TITLE: SYSTEM OVERVIEW	DETAIL NUMBER: 101	

I-1B-16-30-A WEATHERWELD APPLICATION
 30 GAL / 100 SQ. FT. ASPHALT EMULSION
 16 LBS / 100 SQ. FT. FIBERGLASS ROVING

G2 BASE SHEET

DENSDECK PRIME SUBSTRATE
 BOARD

RIGID POLYISOCYANURATE
 INSULATION

APPROVED ROOF
 SUBSTRATE

CA TITLE 24 COOL ROOF REFLECTIVE
 COATING (3 GAL. / 100 SQ.FT.)

6" SELF ADHESIVE
 MEMBRANE

DRIP EDGE METAL
 (MIN. 0.045")

1" [26mm]

CLEAT FASTENED
 EVERY 8" [203mm]

3" [76mm]

3" [76mm]

SYSTEM:

I-1B-16-30-A

Composite Membrane Over
 Approved Substrates

9757 7th Street, Suite 803
 Rancho Cucamonga, CA 91730-5297
 (888) 440-3224 | www.weatherweld.com

PREPARED FOR:

DETAIL NUMBER:

201

EDGE FLASHING

DRAWING TITLE:

WEATHERWELD
 A DIVISION OF LIQUIFORM TECHNOLOGIES, INC.

PROJECT:

DRAWN BY:
R. Weygant

APPROVED BY:
M. Jones

INSTALLED BY:
TBD

DATE:

1/24/24

SCALE:

6" = 1'-0"

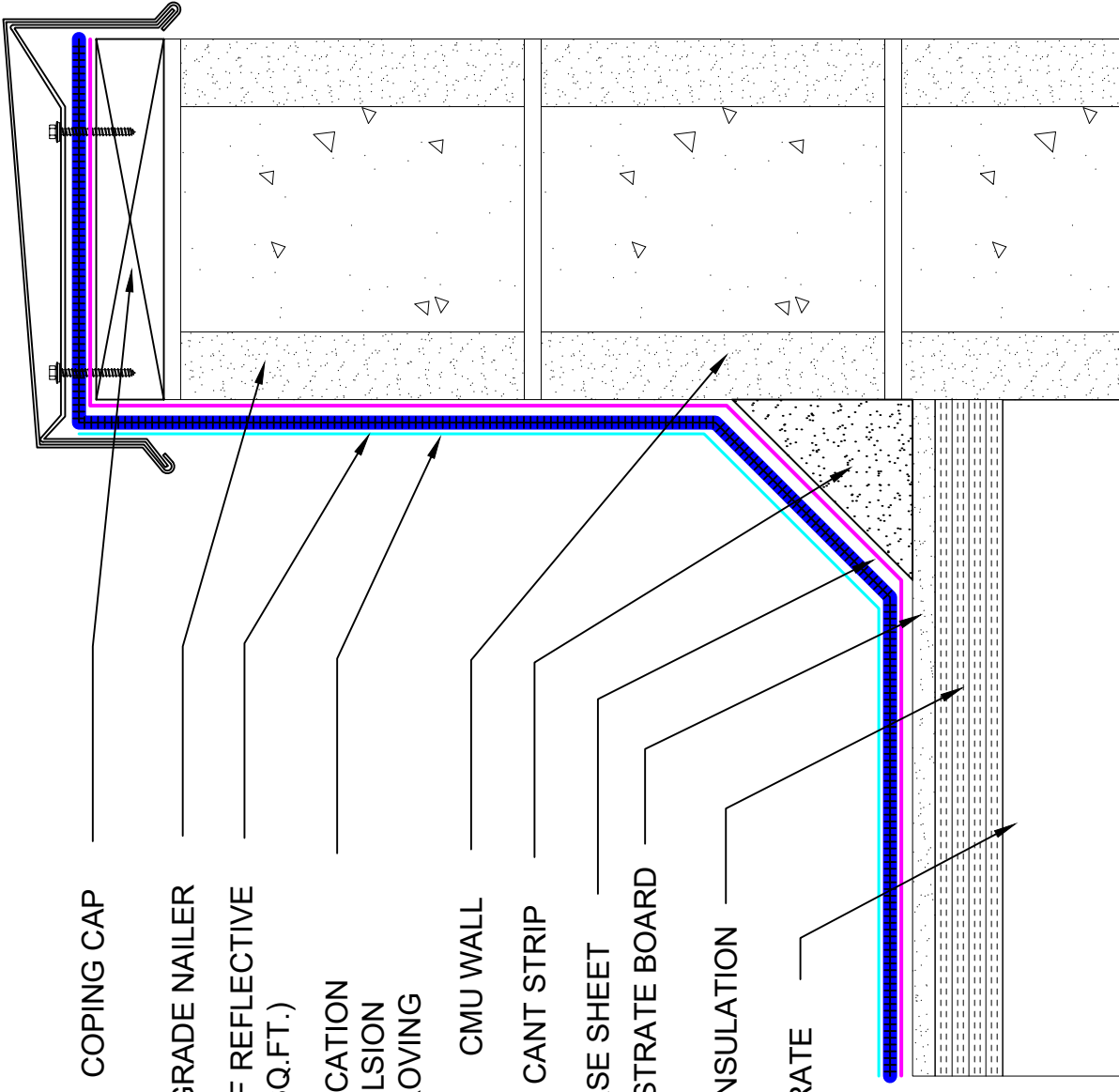

COPING CAP

EXTERIOR GRADE NAILER

CA TITLE 24 COOL ROOF REFLECTIVE COATING (3 GAL. / 100 SQ.FT.)

I-1B-16-30-A WEATHERWELD APPLICATION
30 GAL / 100 SQ. FT. ASPHALT EMULSION
16 LBS / 100 SQ. FT. FIBERGLASS ROVING

CMU WALL

4" CANT STRIP

G2 BASE SHEET

DENSDECK PRIME SUBSTRATE BOARD

RIGID POLYISOCYANURATE INSULATION

APPROVED ROOF SUBSTRATE

SYSTEM:

I-1B-16-30-A

Composite Membrane Over
Approved Substrates

9757 7th Street, Suite 803
Rancho Cucamonga, CA 91730-5297
(888) 440-3224 | www.weatherweld.com

PREPARED FOR:

DETAIL NUMBER:

301

COPING CAP FLASHING AT CMU WALL

DRAWN BY:

R. Weygant

APPROVED BY:

M. Jones

PROJECT:

INSTALLED BY:

TBD

DATE:

1/24/24

SCALE:

3" = 1'-0"

WEATHERWELD
A DIVISION OF LIQUIFORM TECHNOLOGIES, INC.
DRAWING TITLE:

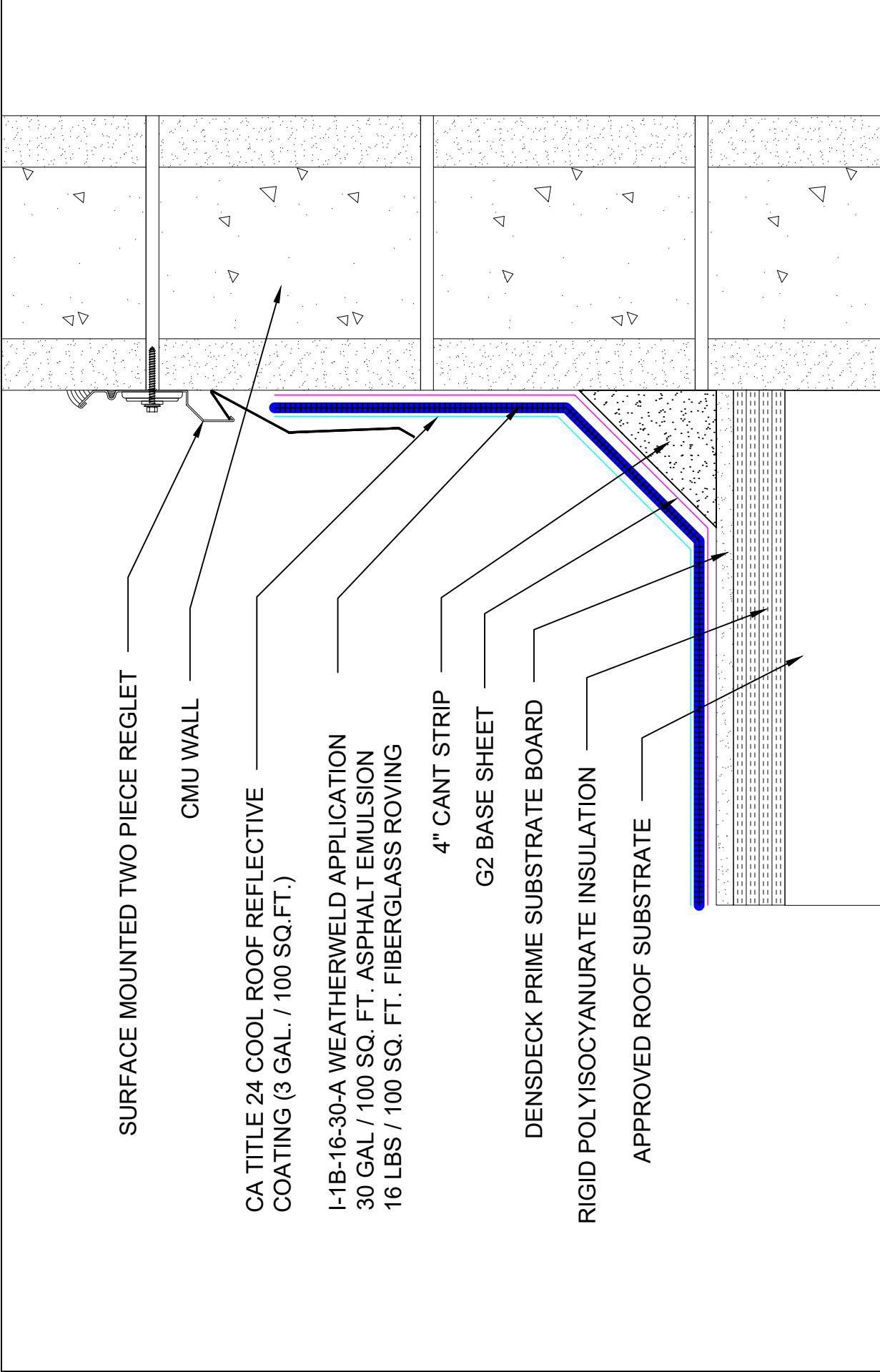

SURFACE MOUNTED TWO PIECE REGLET

CMU WALL

CA TITLE 24 COOL ROOF REFLECTIVE COATING (3 GAL. / 100 SQ.FT.)

I-1B-16-30-A WEATHERWELD APPLICATION 30 GAL / 100 SQ. FT. ASPHALT EMULSION 16 LBS / 100 SQ. FT. FIBERGLASS ROVING

4" CANT STRIP

G2 BASE SHEET

DENSDECK PRIME SUBSTRATE BOARD

RIGID POLYISOCYANURATE INSULATION

APPROVED ROOF SUBSTRATE

SYSTEM:

I-1B-16-30-A

Composite Membrane Over Approved Substrates

9757 7th Street, Suite 803
 Rancho Cucamonga, CA 91730-5297
 (888) 440-3224 | www.weatherweld.com

PREPARED FOR:

DETAIL NUMBER:

302

SURFACE MOUNTED REGLET AT CMU WALL

PROJECT:

DRAWN BY: **R. Weygant**
 APPROVED BY: **M. Jones**

INSTALLED BY: **TBD**
 DATE: **1/24/24**

SCALE: **3" = 1'-0"**

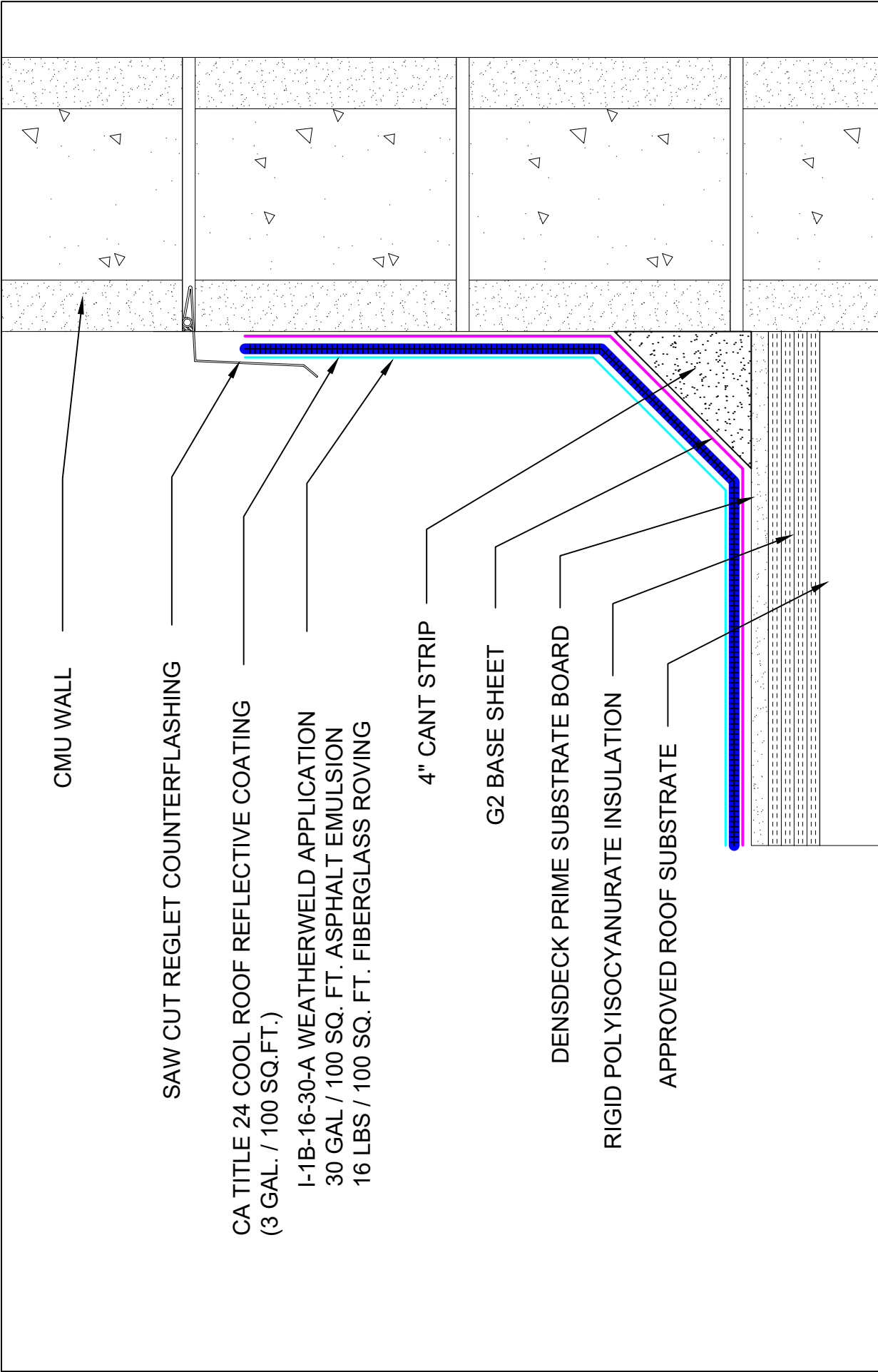

CMU WALL

SAW CUT REGLET COUNTERFLASHING

CA TITLE 24 COOL ROOF REFLECTIVE COATING
(3 GAL. / 100 SQ.FT.)

I-1B-16-30-A WEATHERWELD APPLICATION
30 GAL / 100 SQ. FT. ASPHALT EMULSION
16 LBS / 100 SQ. FT. FIBERGLASS ROVING

4" CANT STRIP

G2 BASE SHEET

DENSDECK PRIME SUBSTRATE BOARD

RIGID POLYISOCYANURATE INSULATION

APPROVED ROOF SUBSTRATE

SYSTEM:

I-1B-16-30-A

Composite Membrane Over
Approved Substrates

PREPARED FOR:
9757 7th Street, Suite 803
Rancho Cucamonga, CA 91730-5297
(888) 440-3224 | www.weatherweld.com

PREPARED FOR:

SAW CUT REGLET AT CMU WALL

DETAIL NUMBER:
303

DRAWN BY:
R. Weygant

APPROVED BY:
M. Jones

PROJECT:
TBD

INSTALLED BY:

DATE:
1/24/24

SCALE:
3" = 1'-0"

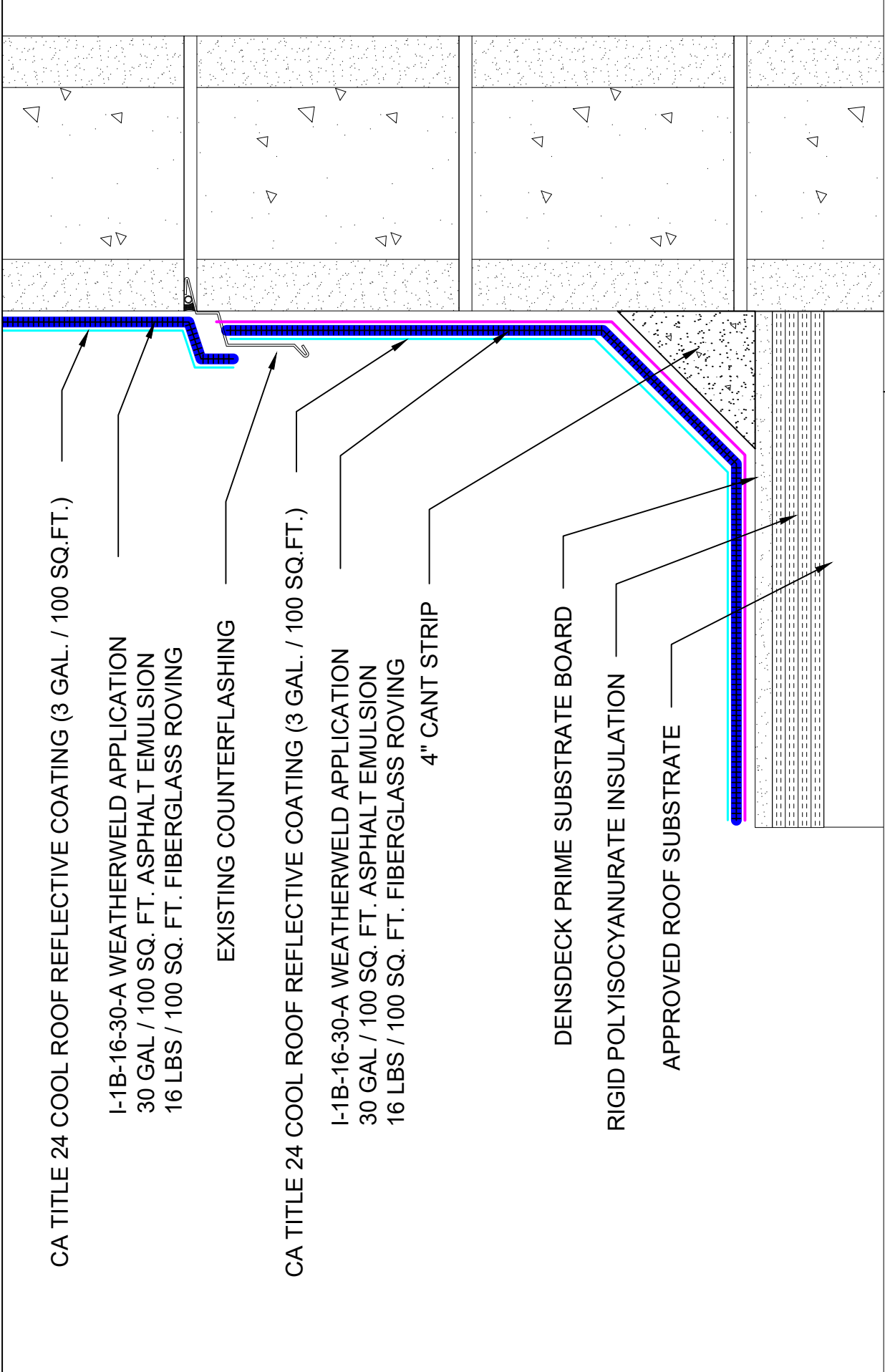

CA TITLE 24 COOL ROOF REFLECTIVE COATING (3 GAL. / 100 SQ.FT.)

I-1B-16-30-A WEATHERWELD APPLICATION
 30 GAL / 100 SQ. FT. ASPHALT EMULSION
 16 LBS / 100 SQ. FT. FIBERGLASS ROVING

EXISTING COUNTERFLASHING

CA TITLE 24 COOL ROOF REFLECTIVE COATING (3 GAL. / 100 SQ.FT.)

I-1B-16-30-A WEATHERWELD APPLICATION
 30 GAL / 100 SQ. FT. ASPHALT EMULSION
 16 LBS / 100 SQ. FT. FIBERGLASS ROVING

4" CANT STRIP

DENSDECK PRIME SUBSTRATE BOARD

RIGID POLYISOCYANURATE INSULATION

APPROVED ROOF SUBSTRATE

SYSTEM:

I-1B-16-30-A

Composite Membrane Over
 Approved Substrates

9757 7th Street, Suite 803
 Rancho Cucamonga, CA 91730-5297
 (888) 440-3224 | www.weatherweld.com

WEATHERWELD
 A DIVISION OF LIQUIFORM TECHNOLOGIES, INC.

DRAWING TITLE:
**CMU WALL WITH EXISTING REGLET
 COUNTERFLASHING**

DETAIL NUMBER:
304

PREPARED FOR:

DRAWN BY:
R. Weygant
 APPROVED BY:
M. Jones

PROJECT:
 INSTALLED BY:
TBD
 DATE:
1/24/24
 SCALE:
3" = 1'-0"

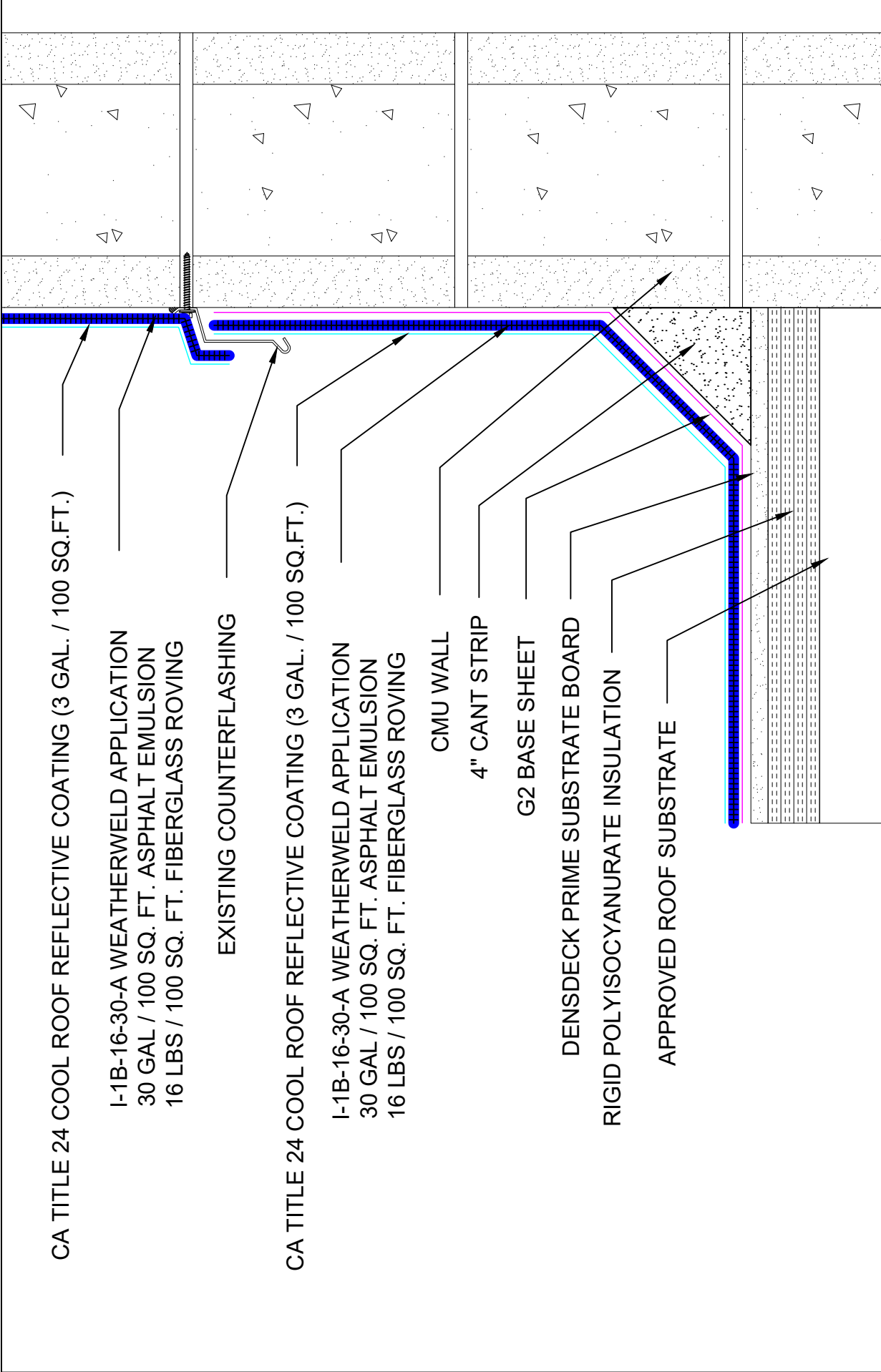

CA TITLE 24 COOL ROOF REFLECTIVE COATING (3 GAL. / 100 SQ.FT.)

I-1B-16-30-A WEATHERWELD APPLICATION
 30 GAL / 100 SQ. FT. ASPHALT EMULSION
 16 LBS / 100 SQ. FT. FIBERGLASS ROVING

EXISTING COUNTERFLASHING

CA TITLE 24 COOL ROOF REFLECTIVE COATING (3 GAL. / 100 SQ.FT.)

I-1B-16-30-A WEATHERWELD APPLICATION
 30 GAL / 100 SQ. FT. ASPHALT EMULSION
 16 LBS / 100 SQ. FT. FIBERGLASS ROVING

CMU WALL

4" CANT STRIP

G2 BASE SHEET

DENSDECK PRIME SUBSTRATE BOARD

RIGID POLYISOCYANURATE INSULATION

APPROVED ROOF SUBSTRATE

SYSTEM:

I-1B-16-30-A

Composite Membrane Over
 Approved Substrates

WEATHERWELD
 A DIVISION OF LIQUIFORM TECHNOLOGIES, INC.
 9757 7th Street, Suite 803
 Rancho Cucamonga, CA 91730-5297
 (888) 440-3224 | www.weatherweld.com

PREPARED FOR:

DETAIL NUMBER:

305

**CMU WALL WITH EXISTING SURFACE
 MOUNTED COUNTERFLASHING**

DRAWN BY:

R. Weygant

PROJECT:

TBD

APPROVED BY:

M. Jones

INSTALLED BY:

TBD

DATE:

1/24/24

SCALE:

3" = 1'-0"

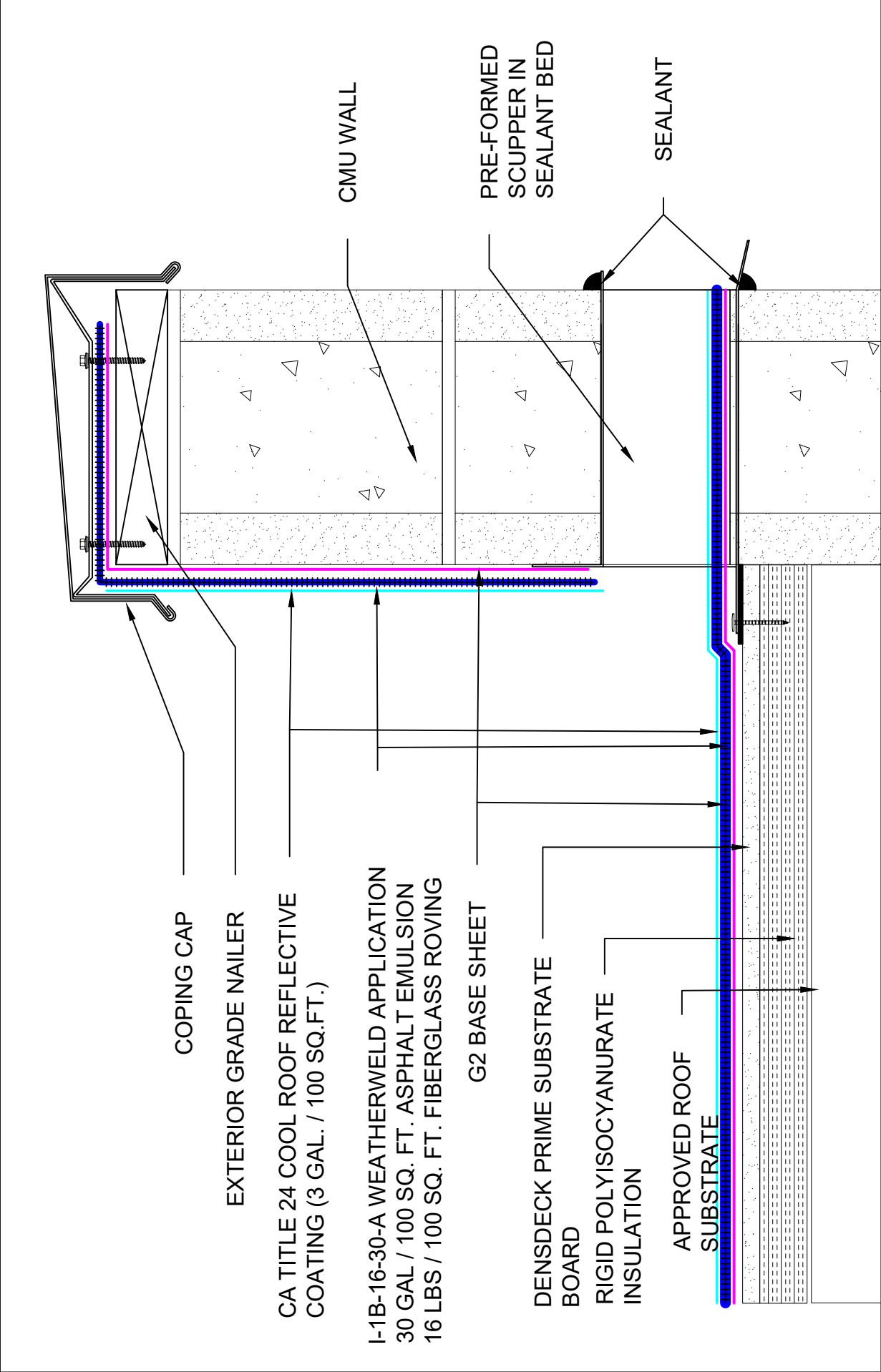

SYSTEM: I-1B-16-30-A Composite Membrane Over Approved Substrates	WEATHERWELD <small>A DIVISION OF LIQUIFORM TECHNOLOGIES, INC.</small>		9757 7 th Street, Suite 803 Rancho Cucamonga, CA 91730-5297 (888) 440-3224 www.weatherweld.com		PREPARED FOR:
	DRAWING TITLE: THRU WALL SCUPPER FLASHING AT CMU WALL		DETAIL NUMBER: 306	PROJECT: R. Weygant	INSTALLED BY: TBD
				APPROVED BY: M. Jones	DATE: 1/24/24
				SCALE: 3" = 1'-0"	

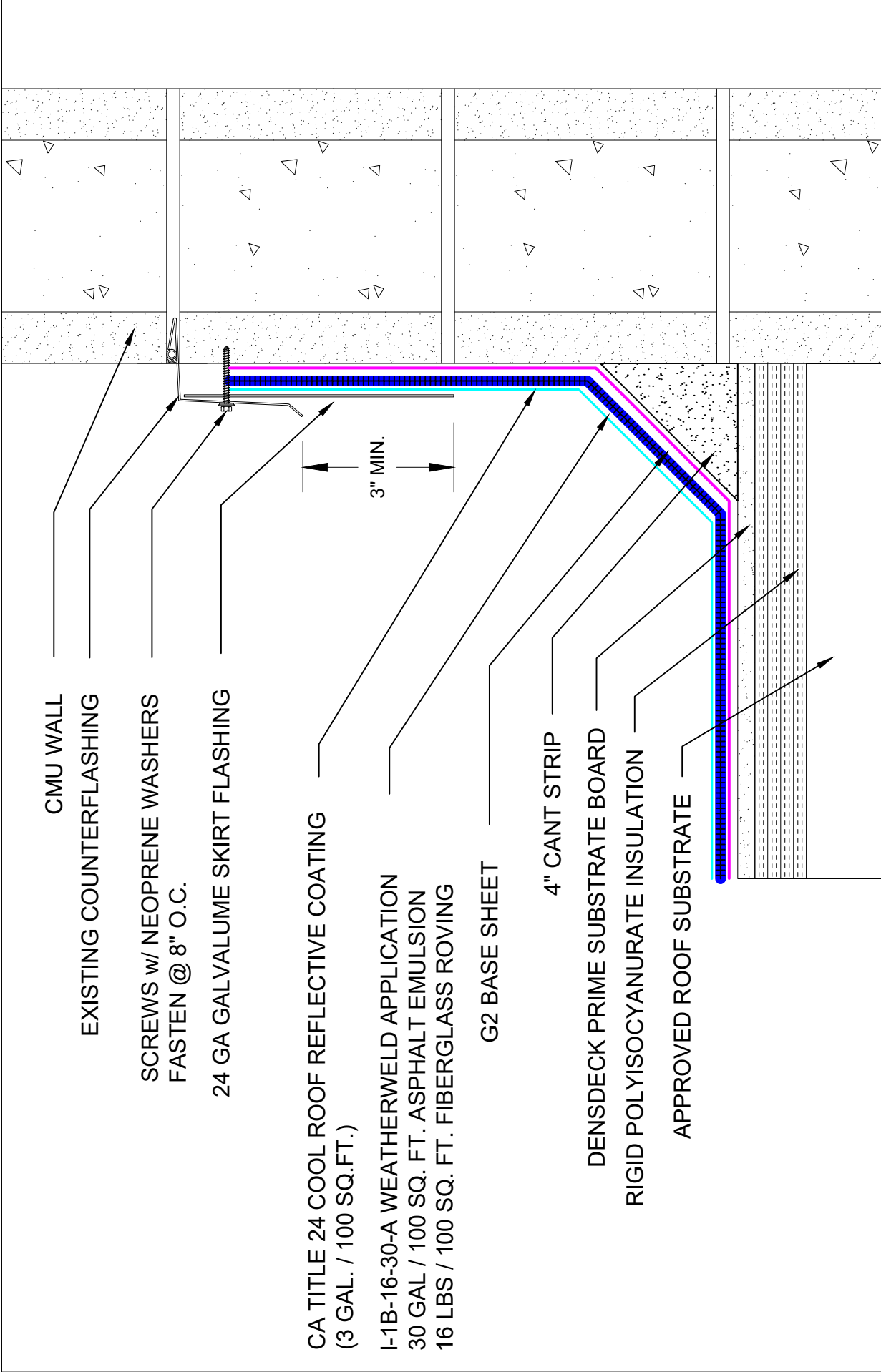

SYSTEM: I-1B-16-30-A Composite Membrane Over Approved Substrates	WEATHERWELD <small>A DIVISION OF LIQUIFORM TECHNOLOGIES, INC.</small>		9757 7 th Street, Suite 803 Rancho Cucamonga, CA 91730-5297 (888) 440-3224 www.weatherweld.com		PREPARED FOR:
	DRAWING TITLE: SKIRTED COUNTERFLASHING AT CMU WALL	DETAIL NUMBER: 307	DRAWN BY: R. Weygant	PROJECT:	INSTALLED BY: TBD
		APPROVED BY: M. Jones			SCALE: 3" = 1'-0"

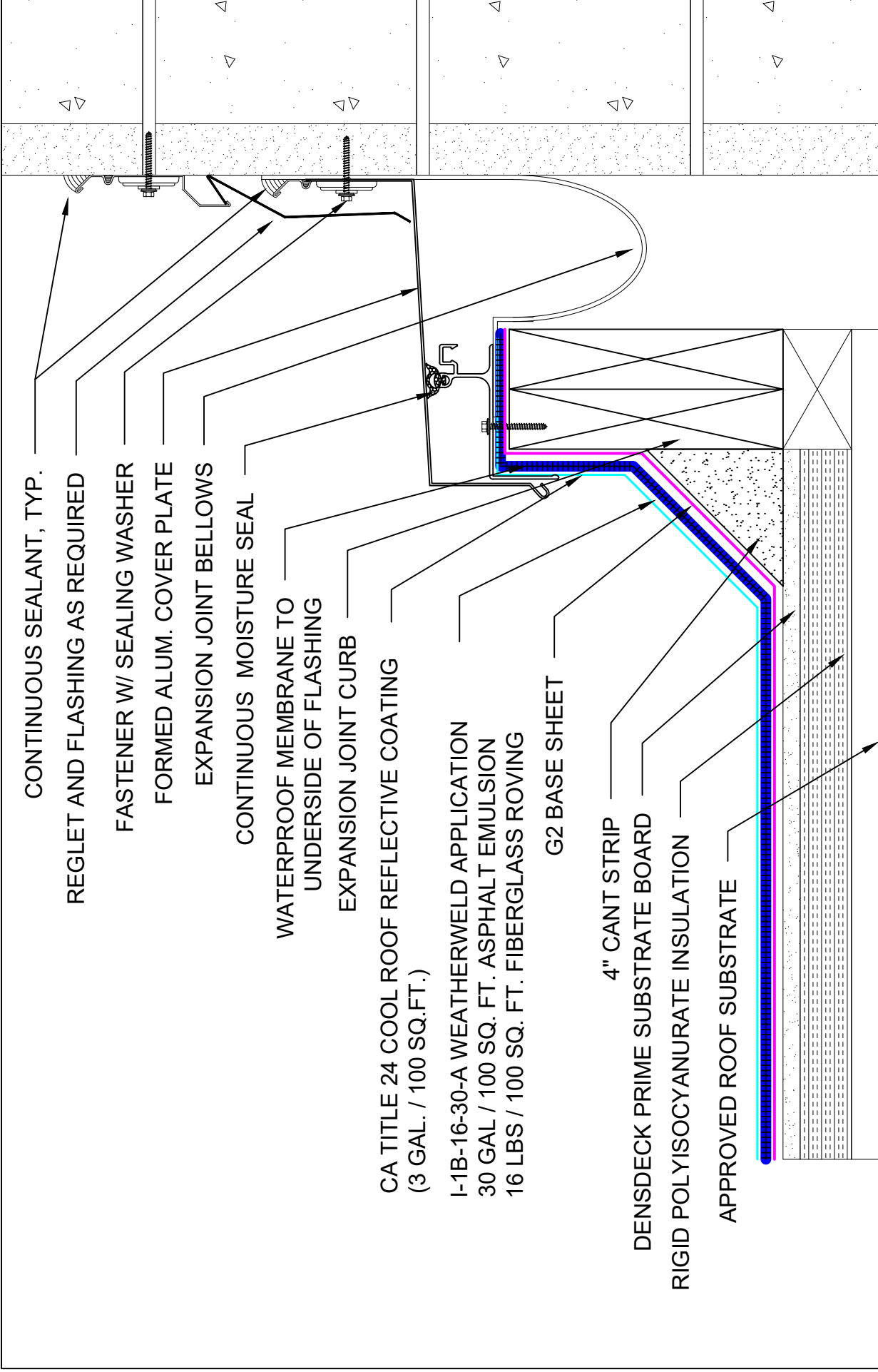

CONTINUOUS SEALANT, TYP.

REGLET AND FLASHING AS REQUIRED

FASTENER W/ SEALING WASHER

FORMED ALUM. COVER PLATE

EXPANSION JOINT BELLOWS

CONTINUOUS MOISTURE SEAL

WATERPROOF MEMBRANE TO
UNDERSIDE OF FLASHING

EXPANSION JOINT CURB

CA TITLE 24 COOL ROOF REFLECTIVE COATING
(3 GAL. / 100 SQ.FT.)

I-1B-16-30-A WEATHERWELD APPLICATION
30 GAL / 100 SQ. FT. ASPHALT EMULSION
16 LBS / 100 SQ. FT. FIBERGLASS ROVING

G2 BASE SHEET

4" CANT STRIP

DENSDECK PRIME SUBSTRATE BOARD

RIGID POLYISOCYANURATE INSULATION

APPROVED ROOF SUBSTRATE

SYSTEM:

I-1B-16-30-A

Composite Membrane Over
Approved Substrates

PREPARED FOR:

9757 7th Street, Suite 803
Rancho Cucamonga, CA 91730-5297
(888) 440-3224 | www.weatherweld.com

PROJECT:

EXPANSION JOINT AT CMU WALL

DETAIL NUMBER:

308

DRAWN BY:

R. Weygant

APPROVED BY:

M. Jones

INSTALLED BY:

TBD

DATE:

1/24/24

SCALE:

3" = 1'-0"

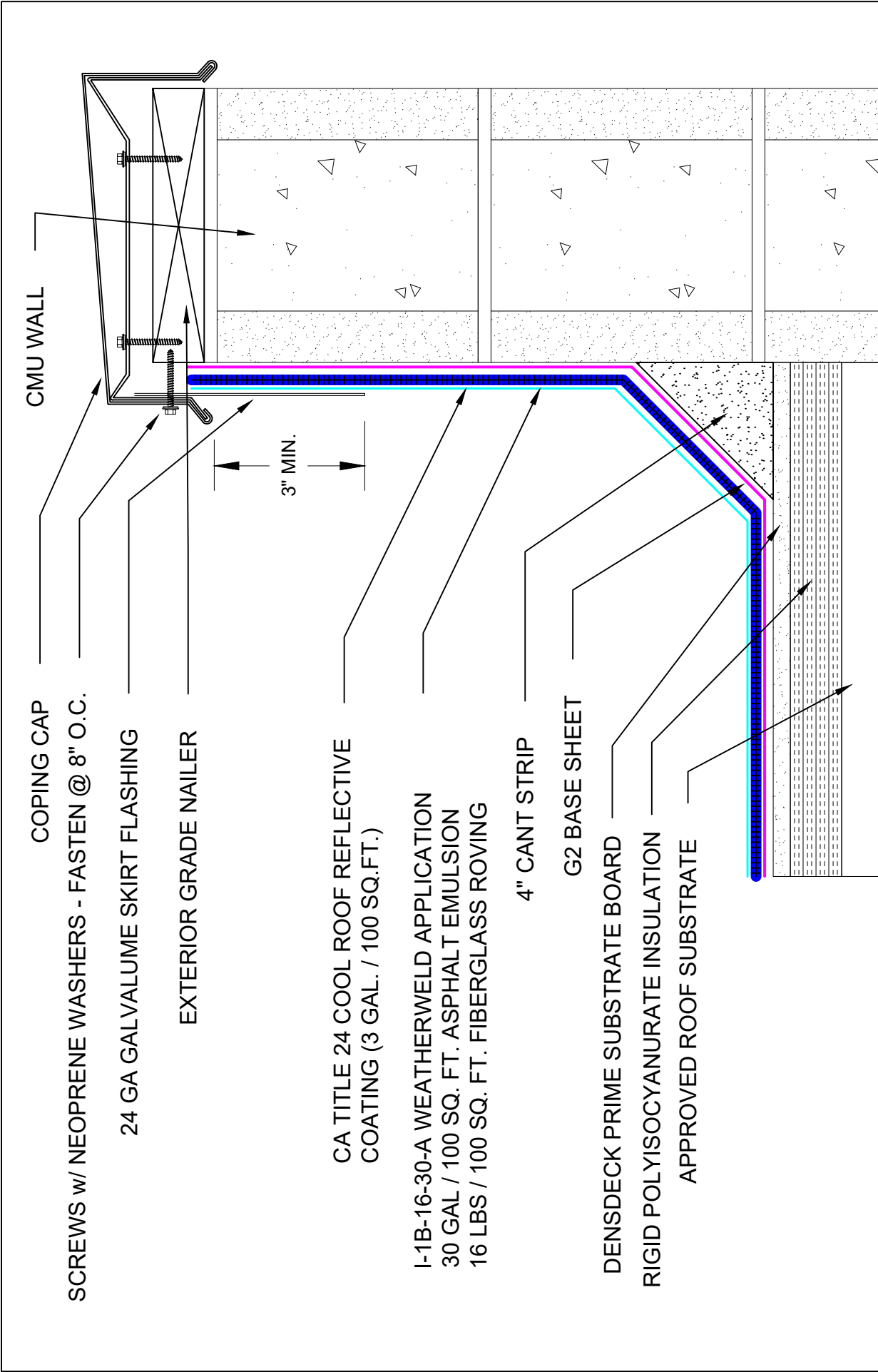

COPING CAP

SCREWS w/ NEOPRENE WASHERS - FASTEN @ 8" O.C.

24 GA GALVALUME SKIRT FLASHING

EXTERIOR GRADE NAILER

3" MIN.

CA TITLE 24 COOL ROOF REFLECTIVE COATING (3 GAL. / 100 SQ.FT.)

I-1B-16-30-A WEATHERWELD APPLICATION
30 GAL / 100 SQ. FT. ASPHALT EMULSION
16 LBS / 100 SQ. FT. FIBERGLASS ROVING

4" CANT STRIP

G2 BASE SHEET

DENSDECK PRIME SUBSTRATE BOARD

RIGID POLYISOCYANURATE INSULATION

APPROVED ROOF SUBSTRATE

CMU WALL

SYSTEM:

I-1B-16-30-A

Composite Membrane Over
Approved Substrates

PREPARED FOR:

9757 7th Street, Suite 803
Rancho Cucamonga, CA 91730-5297
(888) 440-3224 | www.weatherweld.com

WEATHERWELD
A DIVISION OF LIQUIFORM TECHNOLOGIES, INC.

DETAIL NUMBER:

309

SKIRTED COPING DETAIL AT CMU WALL

DRAWN BY:

R. Weygant

APPROVED BY:

M. Jones

PROJECT:

TBD

INSTALLED BY:

1/24/24

DATE:

SCALE:

3" = 1'-0"

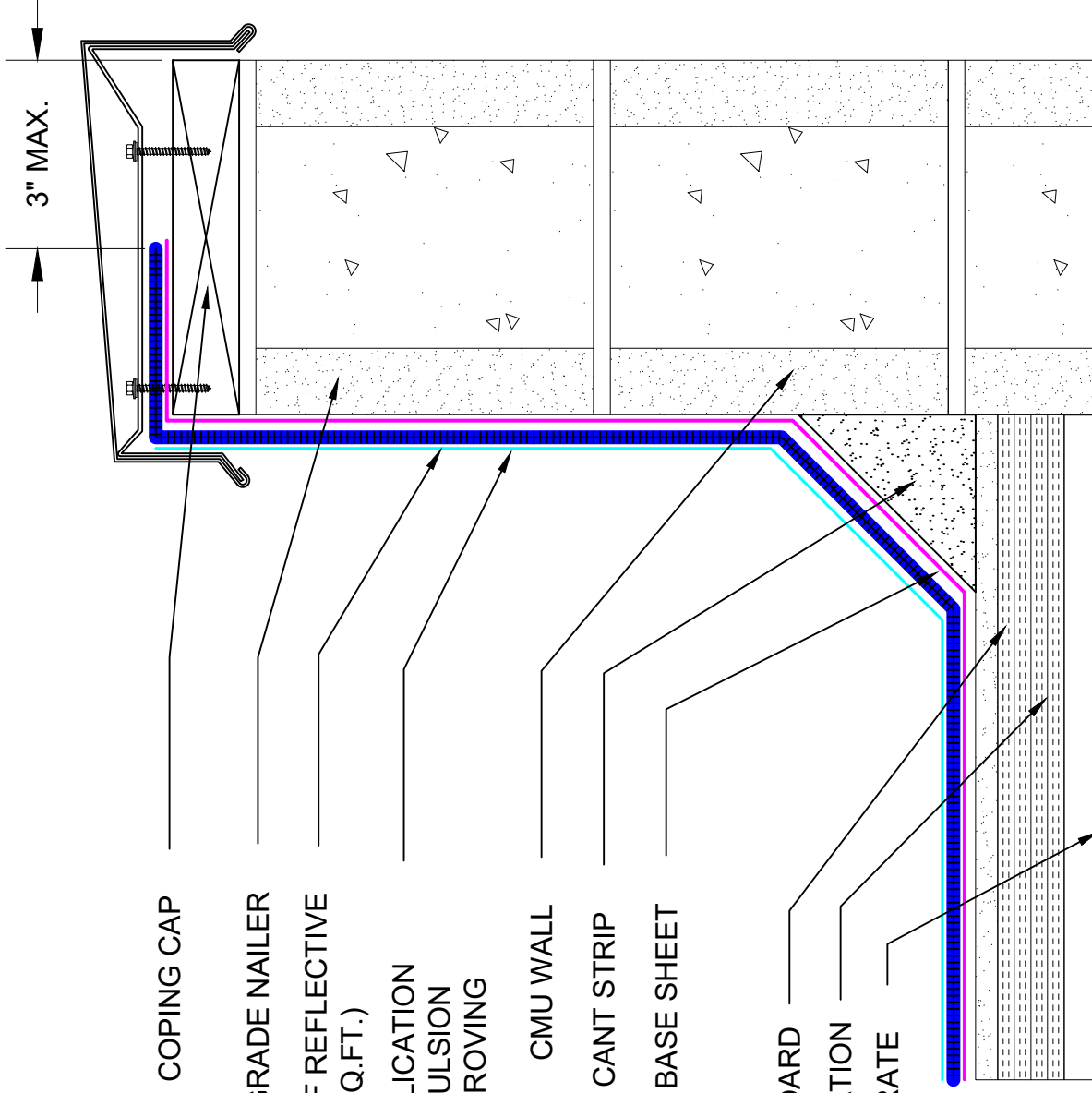

COPING CAP

EXTERIOR GRADE NAILER

CA TITLE 24 COOL ROOF REFLECTIVE COATING (3 GAL. / 100 SQ.FT.)

I-1B-16-30-A WEATHERWELD APPLICATION
 30 GAL / 100 SQ. FT. ASPHALT EMULSION
 16 LBS / 100 SQ. FT. FIBERGLASS ROVING

CMU WALL

4" CANT STRIP

G2 BASE SHEET

DENSDECK PRIME SUBSTRATE BOARD
 RIGID POLYISOCYANURATE INSULATION
 APPROVED ROOF SUBSTRATE

SYSTEM:

I-1B-16-30-A

Composite Membrane Over
 Approved Substrates

9757 7th Street, Suite 803
 Rancho Cucamonga, CA 91730-5297
 (888) 440-3224 | www.weatherweld.com



A DIVISION OF LIQUIFORM TECHNOLOGIES, INC.

COPING DETAIL AT CMU WALL (ALT)

DETAIL NUMBER:
310

PREPARED FOR:

PROJECT:

APPROVED BY:
M. Jones

INSTALLED BY:
TBD

DATE:

1/24/24

SCALE:

3" = 1'-0"

EXPANSION JOINT COVER - INSTALLED IN ACCORDANCE WITH MANUFACTURER'S RECOMMENDATIONS

EXPANSION JOINT CURB

CA TITLE 24 COOL ROOF REFLECTIVE COATING (3 GAL. / 100 SQ.FT.)

I-1B-16-30-A WEATHERWELD APPLICATION
30 GAL / 100 SQ. FT. ASPHALT EMULSION
16 LBS / 100 SQ. FT. FIBERGLASS ROVING

4" CANT STRIP

G2 BASE SHEET

DENSDECK PRIME SUBSTRATE BOARD

RIGID POLYISOCYANURATE INSULATION

APPROVED ROOF SUBSTRATE

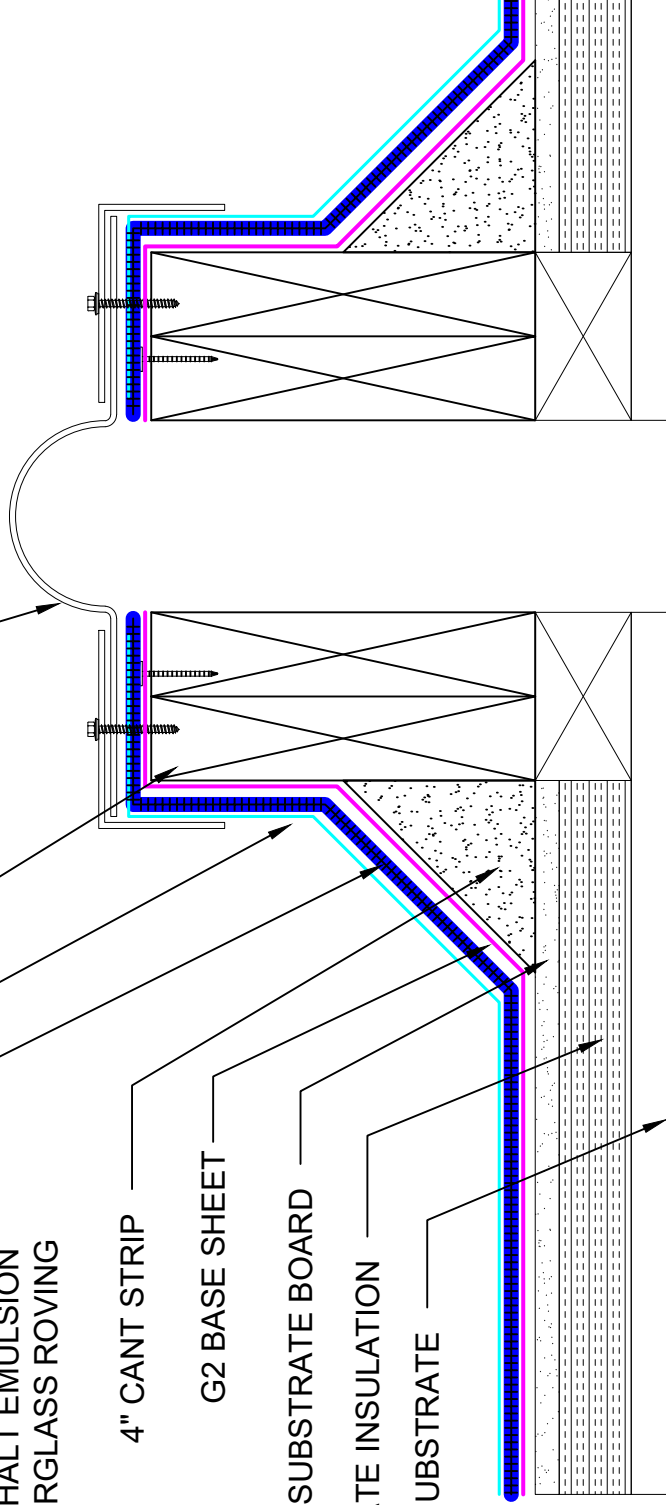

SYSTEM:

I-1B-16-30-A

Composite Membrane Over
Approved Substrates

WEATHERWELD
A DIVISION OF LIQUIFORM TECHNOLOGIES, INC.

9757 7th Street, Suite 803
Rancho Cucamonga, CA 91730-5297
(888) 440-3224 | www.weatherweld.com

PREPARED FOR:

DRAWN BY:

R. Weygant

APPROVED BY:

M. Jones

PROJECT:

TBD

DATE:

1/24/24

SCALE:

3" = 1'-0"

DETAIL NUMBER:

401

EXPANSION JOINT

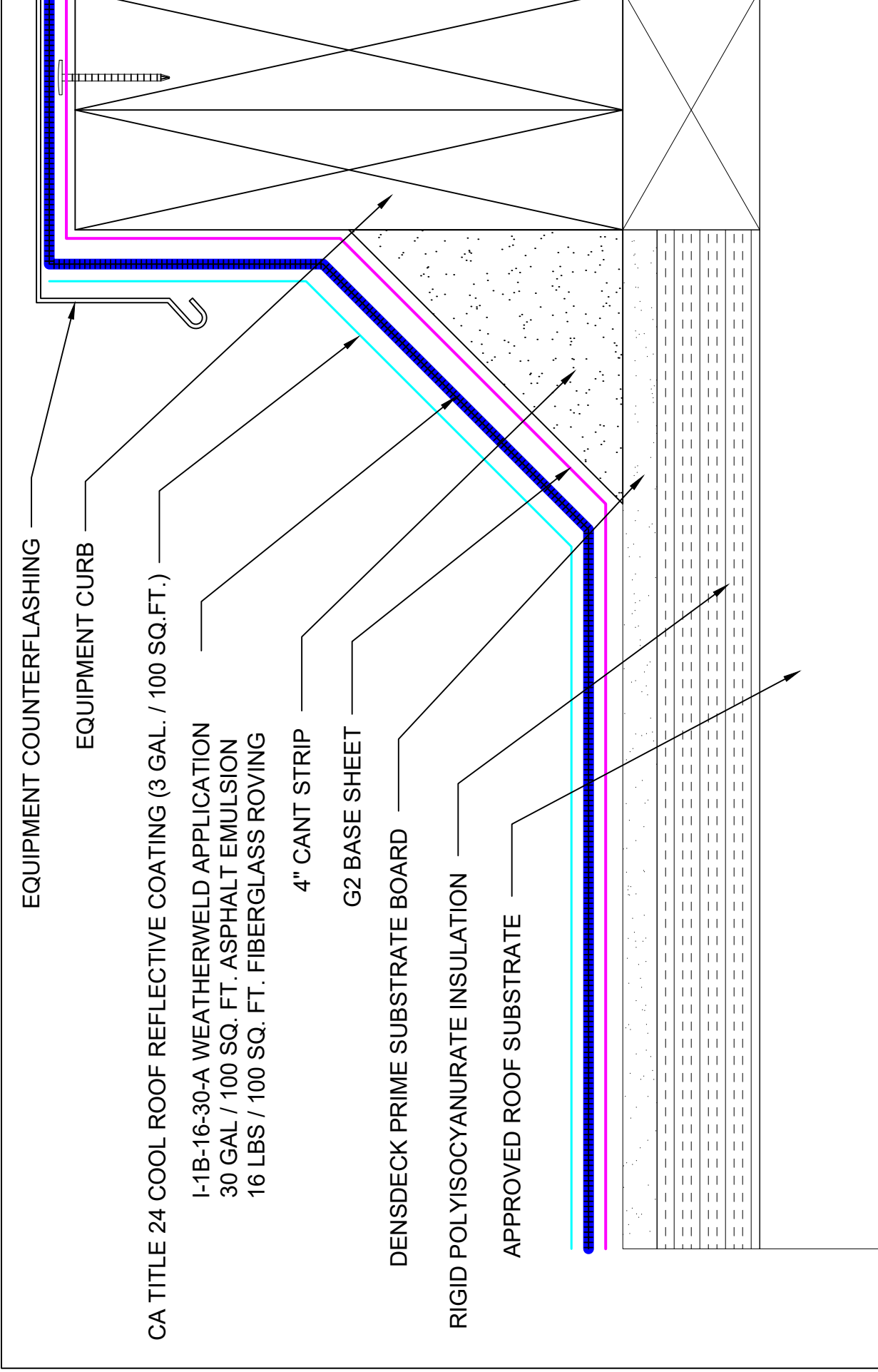

EQUIPMENT COUNTERFLASHING

EQUIPMENT CURB

CA TITLE 24 COOL ROOF REFLECTIVE COATING (3 GAL. / 100 SQ.FT.)

I-1B-16-30-A WEATHERWELD APPLICATION
 30 GAL / 100 SQ. FT. ASPHALT EMULSION
 16 LBS / 100 SQ. FT. FIBERGLASS ROVING

4" CANT STRIP

G2 BASE SHEET

DENSDECK PRIME SUBSTRATE BOARD

RIGID POLYISOCYANURATE INSULATION

APPROVED ROOF SUBSTRATE

SYSTEM:

I-1B-16-30-A

Composite Membrane Over
 Approved Substrates

WEATHERWELD
 A DIVISION OF LIQUIFORM TECHNOLOGIES, INC.
 9757 7th Street, Suite 803
 Rancho Cucamonga, CA 91730-5297
 (888) 440-3224 | www.weatherweld.com

EQUIPMENT CURB FLASHING

DETAIL NUMBER:

402

PREPARED FOR:

PROJECT:

DRAWN BY:
R. Weygant

APPROVED BY:
M. Jones

INSTALLED BY:
TBD

DATE:

1/24/24

SCALE:

6" = 1'-0"

UNIT SKYLIGHT - FASTENED IN ACCORDANCE WITH SKYLIGHT MANUFACTURERS' RECOMMENDATIONS

SKYLIGHT CURB

CA TITLE 24 COOL ROOF REFLECTIVE COATING (3 GAL. / 100 SQ.FT.)

I-1B-16-30-A WEATHERWELD APPLICATION
30 GAL / 100 SQ. FT. ASPHALT EMULSION
16 LBS / 100 SQ. FT. FIBERGLASS ROVING

4" CANT STRIP

G2 BASE SHEET

DENSDECK PRIME SUBSTRATE BOARD

RIGID POLYISOCYANURATE INSULATION

APPROVED ROOF SUBSTRATE

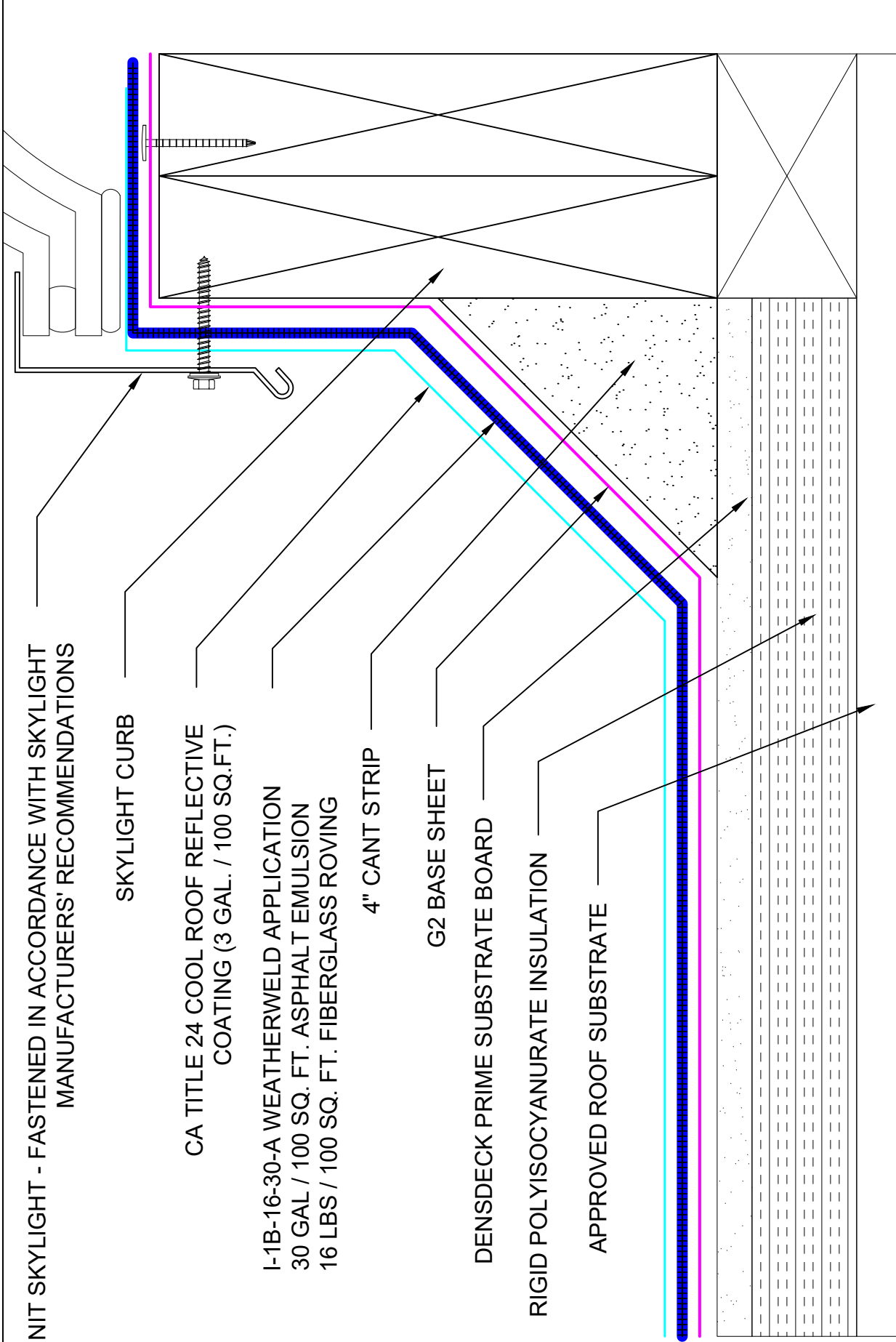

SYSTEM:

I-1B-16-30-A

Composite Membrane Over
Approved Substrates

WEATHERWELD
A DIVISION OF LIQUIFORM TECHNOLOGIES, INC.
9757 7th Street, Suite 803
Rancho Cucamonga, CA 91730-5297
(888) 440-3224 | www.weatherweld.com

DRAWING TITLE:
CURB MOUNTED SKYLIGHT FLASHING

DETAIL NUMBER:
403

PREPARED FOR:

DRAWN BY:
R. Weygant

APPROVED BY:
M. Jones

PROJECT:

INSTALLED BY:
TBD

DATE:
1/24/24

SCALE:
6" = 1'-0"

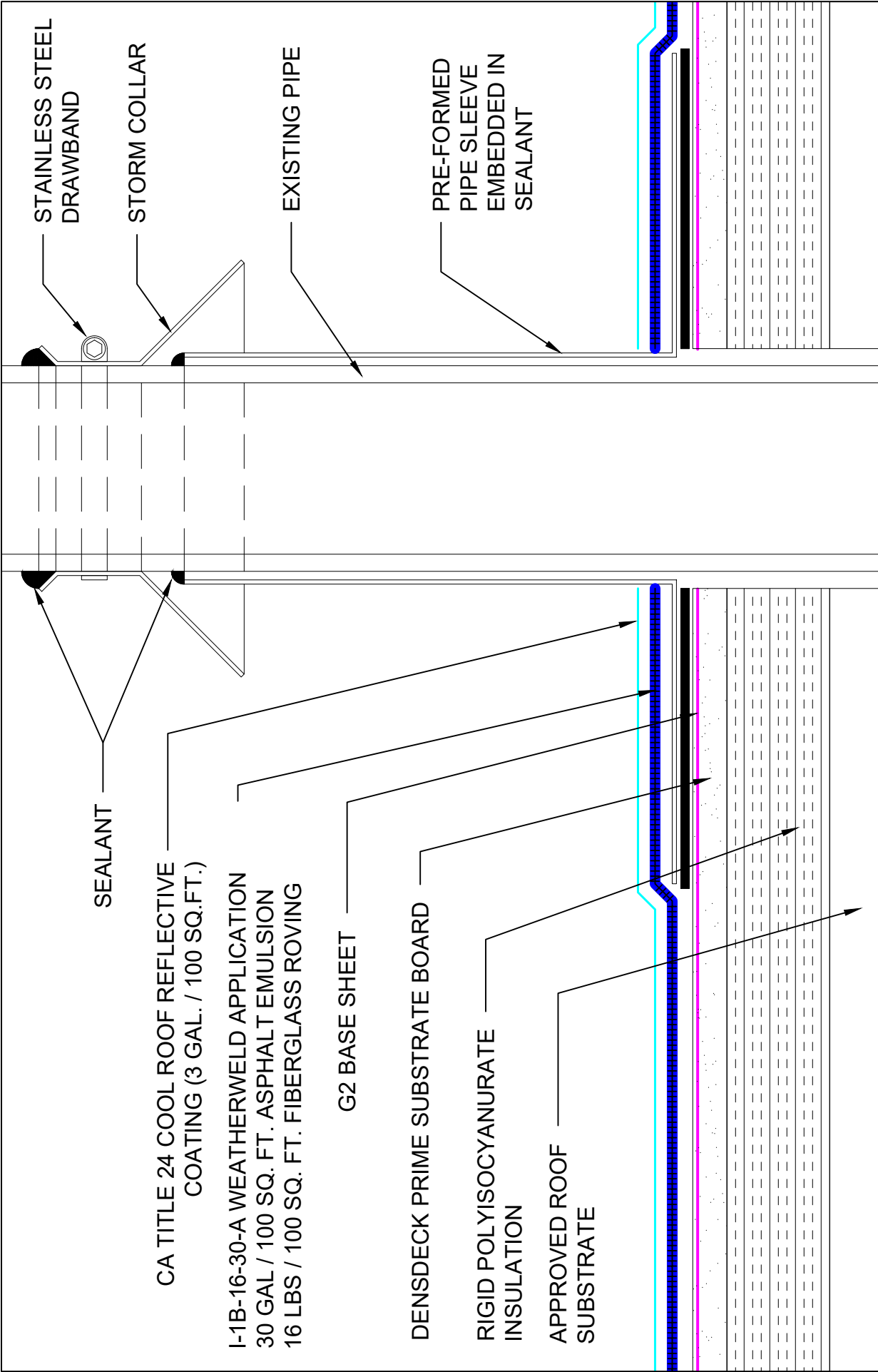

SYSTEM: I-1B-16-30-A Composite Membrane Over Approved Substrates		WEATHERWELD <small>A DIVISION OF LIQUIFORM TECHNOLOGIES, INC.</small> 9757 7 th Street, Suite 803 Rancho Cucamonga, CA 91730-5297 (888) 440-3224 www.weatherweld.com		PREPARED FOR:
DRAWING TITLE: PIPE PENETRATION FLASHING		DETAIL NUMBER: 501	PROJECT: TBD	DATE: 1/24/24
SCALE: 6" = 1'-0"		DRAWN BY: R. Weygant	APPROVED BY: M. Jones	INSTALLED BY: TBD

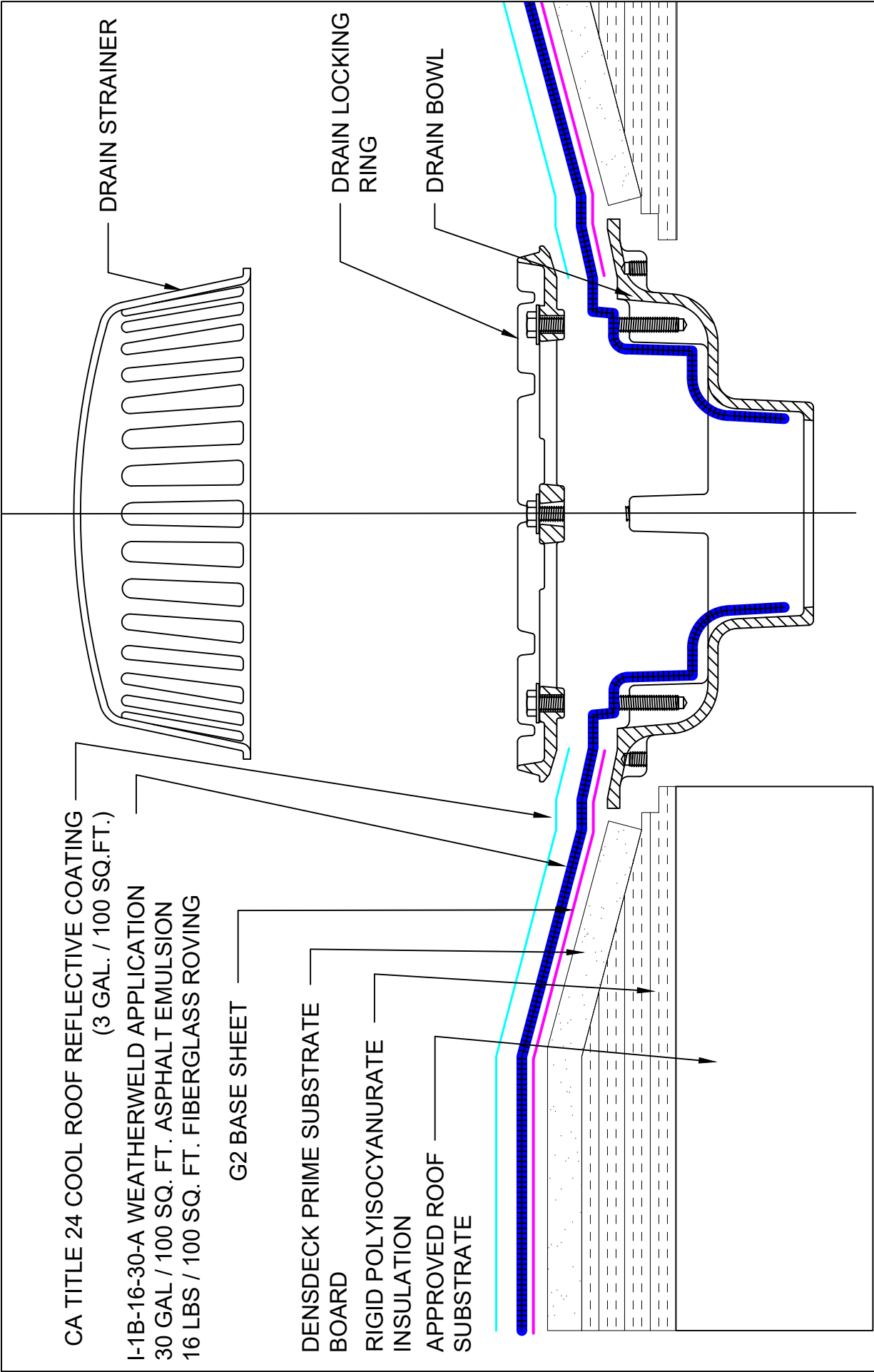

CA TITLE 24 COOL ROOF REFLECTIVE COATING
(3 GAL. / 100 SQ.FT.)

I-1B-16-30-A WEATHERWELD APPLICATION
30 GAL / 100 SQ. FT. ASPHALT EMULSION
16 LBS / 100 SQ. FT. FIBERGLASS ROVING

G2 BASE SHEET

DENSDECK PRIME SUBSTRATE
BOARD

RIGID POLYISOCYANURATE
INSULATION

APPROVED ROOF
SUBSTRATE

DRAIN STRAINER

DRAIN LOCKING
RING

DRAIN BOWL

SYSTEM:

I-1B-16-30-A

Composite Membrane Over
Approved Substrates

9757 7th Street, Suite 803
Rancho Cucamonga, CA 91730-5297
(888) 440-3224 | www.weatherweld.com

PREPARED FOR:

DETAIL NUMBER:

502

DRAIN DETAIL

DRAWING TITLE:

WEATHERWELD
A DIVISION OF LIQUIFORM TECHNOLOGIES, INC.

PROJECT:

DRAWN BY:
R. Weygant

INSTALLED BY:

TBD

DATE:

1/24/24

SCALE:

6" = 1'-0"

8 Fasteners / Board
(1:4 Sq Ft)

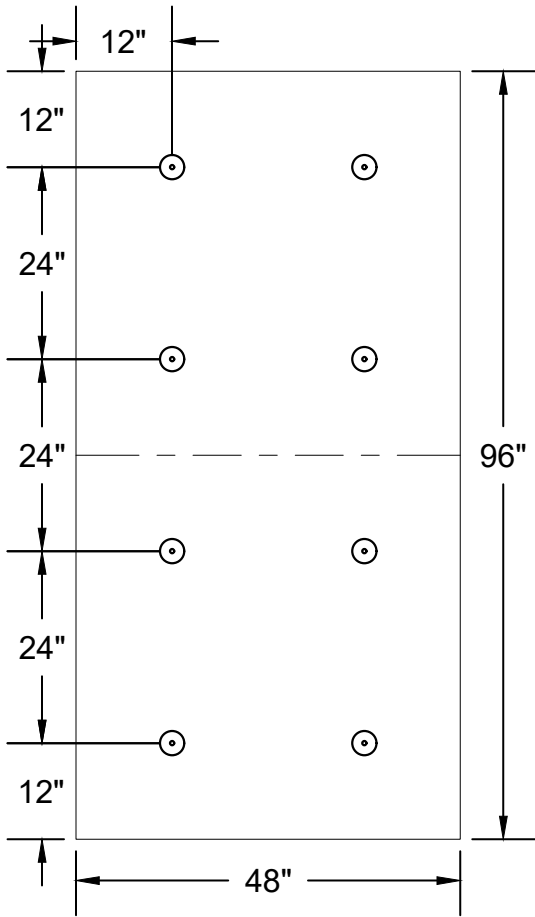

12 Fasteners / Board
(1:2.67 Sq Ft)

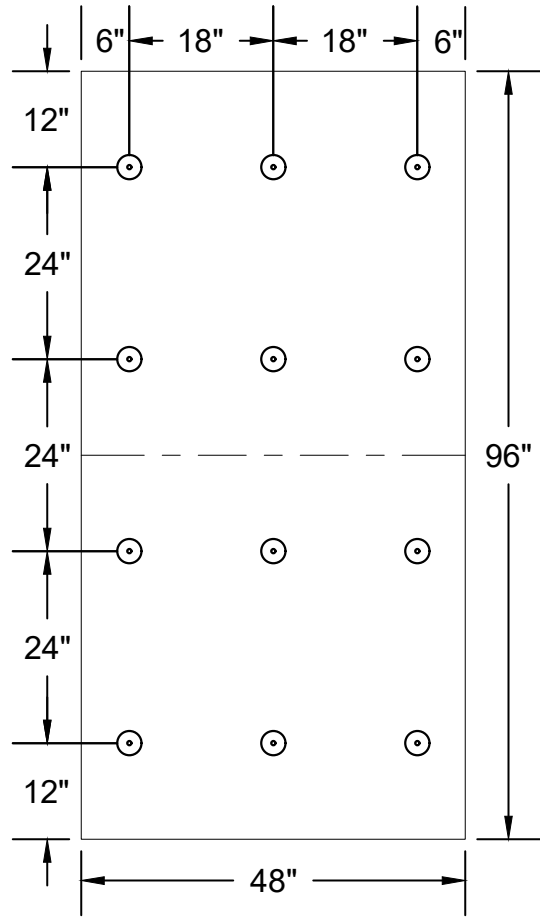

4 Fasteners / Board
(1:4 Sq Ft)

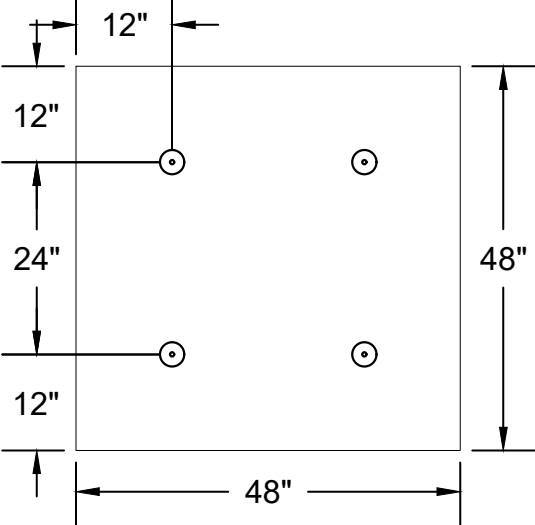

6 Fasteners / Board
(1:2.67 Sq Ft)

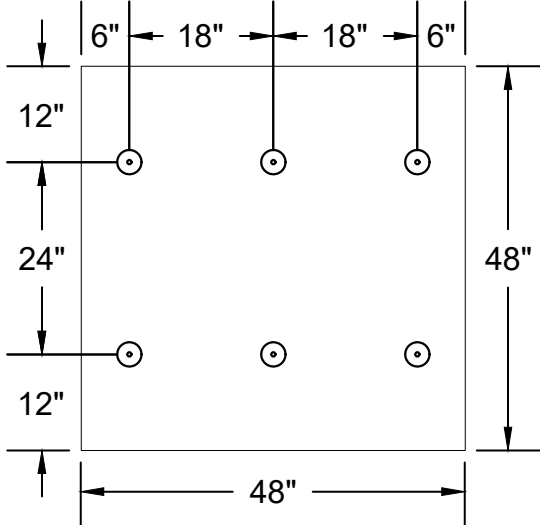

SYSTEM:
I-16-30-A/AL
Seamless Composite Roof
Membrane Over Rigid Insulation



9757 7th Street, Suite 803
Rancho Cucamonga, CA 91730-5297
(888) 440-3224 | www.weatherweld.com

DRAWING TITLE:
INSULATION FASTENING PATTERNS
1:4 FT² AND 1:2.67FT²

DETAIL NUMBER:
601a

PROJECT:

DRAWN BY:
R. Weygant

APPROVED BY:
M. Jones

DATE:
7/24/23

SCALE:
1/2" = 1'-0"

Technical Data Sheets



WW473049 - Cool Roof Reflective Coating is a multi-purpose, acrylic, elastomeric coating for use over a variety of substrates including asphalt and metal roofing. It has unique “bleed blocking” properties which make it particularly suited for coating over asphalt surfaces, and exceeds several ASTM D6083 requirements for tensile strength, elongation, wet adhesion and weatherability.

PERFORMANCE

CERTIFICATIONS

PROPERTY	VALUE
Appearance:	Liquid
Color:	White
Solar Reflectance (Initial / Aged):	0.83 / 0.75 per ASTM C 1549
Thermal Emittance	0.88 / 0.92 per ASTM C 1371
SRI	104 / 93 as Calculated
Initial Tensile Strength:	270 psi per ASTM D 6083
Initial Elongation:	260% per ASTM D 6083
Tear Resistance:	100 lbf / in per ASTM D 6083
1000-hr Accelerated Weathering:	No Cracking or Checking per ASTM D 6083
Elongation After Accelerated Weathering:	220% per ASTM D 6083
Permeance:	12 Perms per ASTM D 6083
Water Swelling:	15% per ASTM D 6083
Fungi Resistance:	No Growth per ASTM D 6083
Solids (Volume / Weight):	52% / 66% per ASTM D 6083
Viscosity:	110 ± 10 KU per ASTM D 6083



MORE INFO

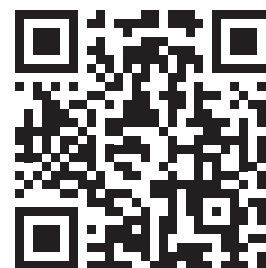

Packaging:

- 1 Gallon Cans
- 55 Gallon Drums
- 250 Gallon Totes

WeatherWeld - A Division of Liquiform Technologies Inc.

9757 7th St. #803 Rancho Cucamonga, CA 91730 | (888) 440-3224 | info@weatherweld.com

Coverage:

1.5 gallons per 100 square feet.

Surface Preparation:

Surface must be clean, dry and in good condition. Remove all debris, loose gravel, and dirt from the roof by brooming or vacuuming and power-wash the entire roof.

Application:

Apply WeatherWeld acrylic top coating to WeatherWeld WW472049 Base Coat at a rate of 1.5 gallons per 100 square feet.

Cleanup:

Clean wet coating from hands and tools with soap and water.

Warnings:

Use appropriate gloves and other protective clothing when handling this product. EMPLOYERS should obtain a copy of the Material Safety Data Sheet (MSDS) from your supplier or directly from WeatherWeld at the toll free number or website below.

Warranty:

Notwithstanding its usage as a component in a No Dollar Limit (NDL) guaranteed roof system, we, the manufacturer, warrant only that this product is free of defects for a period of twelve (12) months from date of original purchase. Many factors may affect the final results obtained from this product, including but not limited to: weather, workmanship, application equipment and prior condition of the application substrate. Proof of purchase is required.

DISCLAIMER OF WARRANTIES AND LIMITATION OF LIABILITY: THIS LIMITED WARRANTY IS IN LIEU OF ANY OTHER WARRANTIES EXPRESS OR IMPLIED INCLUDING BUT NOT LIMITED TO ANY IMPLIED WARRANTY OF MERCHANTABILITY OR FOR A PARTICULAR PURPOSE. MANUFACTURER SHALL HAVE NO LIABILITY OF ANY KIND BEYOND PRODUCT REPLACEMENT, INCLUDING FOR CONSEQUENTIAL OR INCIDENTAL DAMAGES RESULTING FROM ANY DEFECTS OR ANY DELAYS CAUSED BY REPLACEMENT OR OTHERWISE. THIS LIMITED WARRANTY PROVIDES THE PURCHASER'S EXCLUSIVE REMEDY FOR ANY DEFECT IN THE PRODUCT.

WeatherWeld - A Division of Liquiform Technologies Inc.

9757 7th St. #803 Rancho Cucamonga, CA 91730 | (888) 440-3224 | info@weatherweld.com | (888) 440-3224



WW472049 - WeatherWeld acrylic basecoat is a water-carried, acrylic elastomeric coating designed to facilitate proper adhesion of WeatherWeld Title 24 compliant Cool Roof Coating to WeatherWeld emulsion. WW472049 provides superior protection against ponding water and eliminates the need for costly replacement.

PERFORMANCE

CERTIFICATIONS

Property	Value
Appearance:	Liquid
Color:	Buff
Wet Adhesion – Asphalt Emulsion:	5.2 pli per ASTM D 6083
Solids (Volume / Weight):	54% / 67.7% per ASTM D 6083
Viscosity:	110 ± 10 KU per ASTM D 6083
Drying Time:	4-8 hours depending on temperature and humidity.
VOC Content:	< 50 g/l



MORE INFO

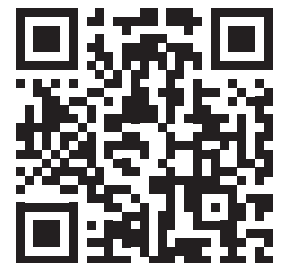

Packaging:

- 1 Gallon Cans
- 5 Gallon Pails
- 55 Gallon Drums
- 250 Gallon Totes

WeatherWeld - A Division of Liquiform Technologies Inc.

9757 7th St. #803 Rancho Cucamonga, CA 91730 | (888) 440-3224 | info@weatherweld.com | (888) 440-3224

Coverage:

1.5 gallons per 100 square feet.

Surface Preparation:

Surface must be clean, dry and in good condition. Remove all debris, loose gravel, and dirt from the roof by brooming or vacuuming and power-wash the entire roof.

Application:

Apply WeatherWeld acrylic basecoat to finished WeatherWeld roof applications at a rate of 1.5 gallons per 100 square feet.

Cleanup:

Clean wet coating from hands and tools with soap and water.

Warnings:

Use appropriate gloves and other protective clothing when handling this product. EMPLOYERS should obtain a copy of the Material Safety Data Sheet (MSDS) from your supplier or directly from WeatherWeld at the toll free number or website below.

Warranty:

We, the manufacturer, warrant only that this product is free of defects, since many factors which affect the results obtained from this product - such as weather, workmanship, equipment utilized and prior condition of the substrate - are all beyond our control. We will replace at no charge any product proved to be defective within 12 months of purchase, provided it has been applied in accordance with our written directions for uses we recommended as suitable for this product. Proof of purchase must be provided.

DISCLAIMER OF WARRANTIES AND LIMITATION OF LIABILITY: THIS LIMITED WARRANTY IS IN LIEU OF ANY OTHER WARRANTIES EXPRESS OR IMPLIED INCLUDING BUT NOT LIMITED TO ANY IMPLIED WARRANTY OF MERCHANTABILITY OR FOR A PARTICULAR PURPOSE. MANUFACTURER SHALL HAVE NO LIABILITY OF ANY KIND BEYOND PRODUCT REPLACEMENT, INCLUDING FOR CONSEQUENTIAL OR INCIDENTAL DAMAGES RESULTING FROM ANY DEFECTS OR ANY DELAYS CAUSED BY REPLACEMENT OR OTHERWISE. THIS LIMITED WARRANTY PROVIDES THE PURCHASER'S EXCLUSIVE REMEDY FOR ANY DEFECT IN THE PRODUCT.

WeatherWeld - A Division of Liquiform Technologies Inc.

9757 7th St. #803 Rancho Cucamonga, CA 91730 | (888) 440-3224 | info@weatherweld.com | (888) 440-3224



WW471145 - Weatherweld Asphalt Emulsion is the primary waterproofing component of WeatherWeld roofing systems and is applied simultaneously with WeatherWeld fiberglass. A colloid mixture of water, asphalt, and bentonite clay, WeatherWeld asphalt emulsion is water-carried, low odor, UV stable and 0 VOC.

PERFORMANCE

CERTIFICATIONS

PROPERTY	VALUE
Appearance:	Thixotropic liquid
Color:	Black
Flash Point:	Non-Flammable.
Maximum VOC:	0 g/l Calculated
Solids Content by Volume:	49-53% per ASTM D 2697
Viscosity (Brookfield):	8,000-15,000 cPs per ASTM D 2196





MORE INFO

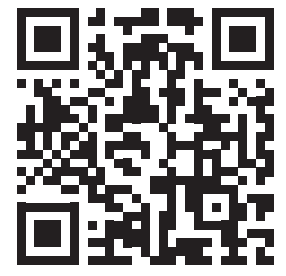

- Packaging:**
- 1 Gallon Cans
 - 5 Gallon Pails
 - 55 Gallon Drums
 - 275 Gallon Totes
 - Bulk Delivery

WeatherWeld - A Division of Liquiform Technologies Inc.

9757 7th St. #803 Rancho Cucamonga, CA 91730 | (888) 440-3224 | info@weatherweld.com | (888) 440-3224

Coverage:

30 to 45 gallons per 100 square feet depending on application.

Surface Preparation:

Surface must be clean, dry and in good condition. Remove all debris, loose gravel, and dirt from the roof by brooming or vacuuming and power-wash the entire roof.

Application:

Emulsion is spray applied using the WeatherWeld 3D Roof Printer. Emulsion is simultaneously applied with glass fibers to provide a seamless reinforced roof membrane.

Cleanup:

Clean wet coating from hands and tools with soap and water. If dry, clean tools with kerosene, paint thinner or mineral spirits.

Warnings:

Use appropriate gloves and other protective clothing when handling this product. EMPLOYERS should obtain a copy of the Material Safety Data Sheet (MSDS) from your supplier or directly from WeatherWeld at the toll free number or website below.

Warranty:

We, the manufacturer, warrant only that this product is free of defects, since many factors which affect the results obtained from this product - such as weather, workmanship, equipment utilized and prior condition of the substrate - are all beyond our control. We will replace at no charge any product proved to be defective within 12 months of purchase, provided it has been applied in accordance with our written directions for uses we recommended as suitable for this product. Proof of purchase must be provided.

DISCLAIMER OF WARRANTIES AND LIMITATION OF LIABILITY: THIS LIMITED WARRANTY IS IN LIEU OF ANY OTHER WARRANTIES EXPRESS OR IMPLIED INCLUDING BUT NOT LIMITED TO ANY IMPLIED WARRANTY OF MERCHANTABILITY OR FOR A PARTICULAR PURPOSE. MANUFACTURER SHALL HAVE NO LIABILITY OF ANY KIND BEYOND PRODUCT REPLACEMENT, INCLUDING FOR CONSEQUENTIAL OR INCIDENTAL DAMAGES RESULTING FROM ANY DEFECTS OR ANY DELAYS CAUSED BY REPLACEMENT OR OTHERWISE. THIS LIMITED WARRANTY PROVIDES THE PURCHASER'S EXCLUSIVE REMEDY FOR ANY DEFECT IN THE PRODUCT.

WeatherWeld - A Division of Liquiform Technologies Inc.

9757 7th St. #803 Rancho Cucamonga, CA 91730 | (888) 440-3224 | info@weatherweld.com | (888) 440-3224

WW474049 - WeatherWeld self adhering membrane is a modified roofing membrane sheet with a self sticking adhesive backing used as a general flashing sheet at transitions, terminations, and flashings. Self adhering is also used to bridge gaps and as a field repair tape before WeatherWeld applications

PERFORMANCE

PROPERTY	VALUE
Appearance:	Rough Sanded Texture
Color:	Black
Strip Tensile Strength:	75 Lbs/in (13,135 N/m) per ASTM D 882
Puncture Resistance:	200 Lbs (890 N) per ASTM E 154
Permeance:	Max 0.05 Perms per ASTM E 96 Method B
Pliability:	No cracks when tested with a 1/4" Mandrel, 180 deg. Blend at -25F, per ASTM D 146

CERTIFICATIONS

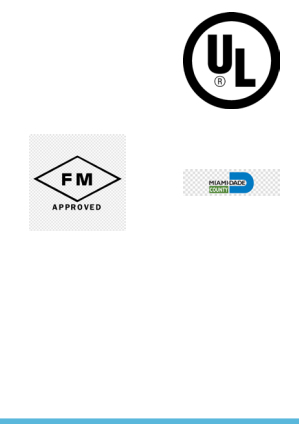

MORE INFO

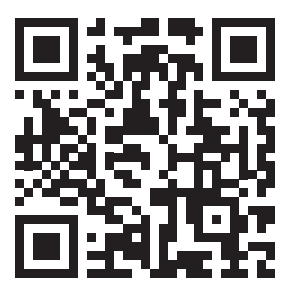

Packaging:

- 12 in. X 108 ft. (0.31 m x 32.9 m) Roll.
- 18 in. X 108 ft. (0.46 m x 32.9 m) Roll.
- 24 in. X 108 ft. (0.61 m x 32.9 m) Roll.
- 36 in. X 45 ft. (0.91 m x 13.7 m) Roll.

Coverage:

Coverage dependent on Roll size.

Surface Preparation:

Surface must be clean, dry and in good condition. Remove all debris, loose gravel, and dirt from the roof by brooming or vacuuming and power-wash the entire roof.

Application:**Cleanup:**

Clean with soap and water. If dry, clean tools with kerosene, paint thinner or mineral spirits.

Warnings:

Use appropriate gloves and other protective clothing when handling this product. EMPLOYERS should obtain a copy of the Material Safety Data Sheet (MSDS) from your supplier or directly from WeatherWeld at the toll free number or website below.

Warranty:

Notwithstanding its usage as a component in a No Dollar Limit (NDL) guaranteed roof system, we, the manufacturer, warrant only that this product is free of defects for a period of twelve (12) months from date of original purchase. Many factors may affect the final results obtained from this product, including but not limited to: weather, workmanship, application equipment and prior condition of the application substrate. Proof of purchase is required.

DISCLAIMER OF WARRANTIES AND LIMITATION OF LIABILITY: THIS LIMITED WARRANTY IS IN LIEU OF ANY OTHER WARRANTIES EXPRESS OR IMPLIED INCLUDING BUT NOT LIMITED TO ANY IMPLIED WARRANTY OF MERCHANTABILITY OR FOR A PARTICULAR PURPOSE. MANUFACTURER SHALL HAVE NO LIABILITY OF ANY KIND BEYOND PRODUCT REPLACEMENT, INCLUDING FOR CONSEQUENTIAL OR INCIDENTAL DAMAGES RESULTING FROM ANY DEFECTS OR ANY DELAYS CAUSED BY REPLACEMENT OR OTHERWISE. THIS LIMITED WARRANTY PROVIDES THE PURCHASER'S EXCLUSIVE REMEDY FOR ANY DEFECT IN THE PRODUCT.

WeatherWeld - A Division of Liquiform Technologies Inc.

9757 7th St. #803 Rancho Cucamonga, CA 91730 | (888) 440-3224 | info@weatherweld.com | (888) 440-3224



WWFG100 - Fiberglass Roving is continuous filament glass fiber consisting of approximately sixty strands held together loosely in rope form by a special sizing. Roving is designed for spray application using the WeatherWeld 3D Roof Printer to provide reinforcement for WeatherWeld asphalt emulsion coating.

PERFORMANCE

CERTIFICATIONS

PROPERTY	VALUE
Appearance:	Ropelike strands
Color:	White
Flash Point:	>212F
Maximum VOC:	0 g/l
Maximum VOS:	0 lbs/gal
Fiber Diameter:	6 microns, minimum
Yield:	207 yd/lb.
Tex:	2400 g/km.



MORE INFO

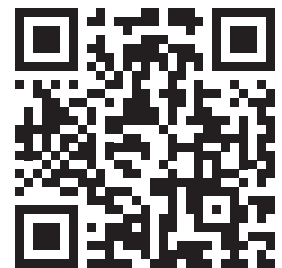

Packaging:

Each spool is capable of covering approximately 1350 square feet of area when applied at a rate of 3 lbs per 100 square feet.

WeatherWeld - A Division of Liquiform Technologies Inc.

9757 7th St. #803 Rancho Cucamonga, CA 91730 | (888) 440-3224 | info@weatherweld.com

Coverage:

Normal application rate is 30 gallons of WeatherWeld Asphalt Emulsion and 16 pounds of glass fiber per 100 square feet.

Surface Preparation:

Follow directions on surface preparation for WW471145 WeatherWeld Asphalt Emulsion Application

Application:

Roving is spray applied using the WeatherWeld 3D Roof Printer to provide reinforcement for WeatherWeld asphalt emulsion. Emulsion and glass fibers are chopped into a matrix of intertwined strands ranging in length from 1" to 24" and simultaneously applied providing a seamless reinforced roof membrane.

Cleanup:

Wash hands with soap and water when finished.

Warnings:

Use appropriate gloves and other protective clothing when handling this product. EMPLOYERS should obtain a copy of the Material Safety Data Sheet (MSDS) from your supplier or directly from WeatherWeld at the toll free number or website below.

Warranty:

Notwithstanding its usage as a component in a No Dollar Limit (NDL) guaranteed roof system, we, the manufacturer, warrant only that this product is free of defects for a period of twelve (12) months from date of original purchase. Many factors may affect the final results obtained from this product, including but not limited to: weather, workmanship, application equipment and prior condition of the application substrate. Proof of purchase is required.

DISCLAIMER OF WARRANTIES AND LIMITATION OF LIABILITY: THIS LIMITED WARRANTY IS IN LIEU OF ANY OTHER WARRANTIES EXPRESS OR IMPLIED INCLUDING BUT NOT LIMITED TO ANY IMPLIED WARRANTY OF MERCHANTABILITY OR FOR A PARTICULAR PURPOSE. MANUFACTURER SHALL HAVE NO LIABILITY OF ANY KIND BEYOND PRODUCT REPLACEMENT, INCLUDING FOR CONSEQUENTIAL OR INCIDENTAL DAMAGES RESULTING FROM ANY DEFECTS OR ANY DELAYS CAUSED BY REPLACEMENT OR OTHERWISE. THIS LIMITED WARRANTY PROVIDES THE PURCHASER'S EXCLUSIVE REMEDY FOR ANY DEFECT IN THE PRODUCT.

WeatherWeld - A Division of Liquiform Technologies Inc.



9757 7th St. #803 Rancho Cucamonga, CA 91730 | (888) 440-3224 | info@weatherweld.com | (888) 440-3224

WW33333 - Base Sheet is a heavy duty asphalt coated sheet manufactured to meet the requirements of ASTM D 4601, Type II and Fed. Spec. SS-R-602B, Type III. A heavyweight non-woven fiberglass mat makes it particularly suitable for use in fire retardant assemblies. Applied with cold asphalt cement. Unlike saturated felt or lightweight fiberglass ply sheet, WW33333 - Base Sheet is coated with asphalt on both sides and reacts with the solvents in cold cement to provide excellent adhesion without decrease in tensile strength. It has lay lines appropriate for normal roofing side laps. The surface of the sheet is lightly sprinkled with sand to prevent sticking.

PERFORMANCE

CERTIFICATIONS

PROPERTY	VALUE
Appearance:	Fabric
Color:	Black
Flash Point:	500F
Maximum VOC:	0 g/l Calculated
Maximum VOS:	0 lbs/gal
Tensile Strength:	MD 75 lbf/in, CD 60 lbf/in per ASTM D 4601



MORE INFO

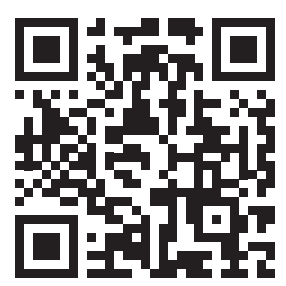

Packaging:
36 in. X 72 ft. Rolls

Coverage:

Approximately 190 square feet per roll.

Surface Preparation:

All surfaces to be receive base sheet must be clean, dry, smooth and flat, and must be free of oil, grease, rust, scale, loose paint, dirt, and all foreign matter that may interfere with installation. Remove and replace loose or erupted fasteners which may pucture the base sheet.

Application:

Application details as specified for each particular roof system or project are to be followed, as they may vary. Prior to application, cut the rolls into lengths suitable for installation and lay flat to eliminate curl. Unless otherwise specified, the base ply is laid with 2" side laps and 4" end laps and nailed, spot-adhered or fully adhered with cold application cement or hot asphalt. Subsequently, plies are completely adhered, cold or hot method.

Cleanup:

Asphalt can be removed by use of mineral spirits, paint remover or kerosene. Use caution when handling solvents.

Warnings:

This product contains detectable amounts of chemicals known to the State of California to cause cancer, or birth defects or other reproductive harm. Employers should obtain a copy of the Material Safety Data Sheet (MSDS) from your supplier or directly from WeatherWeld at the toll free number or website below.

Warranty:

Notwithstanding its usage as a component in a No Dollar Limit (NDL) guaranteed roof system, we, the manufacturer, warrant only that this product is free of defects for a period of twelve (12) months from date of original purchase. Many factors may affect the final results obtained from this product, including but not limited to: weather, workmanship, application equipment and prior condition of the application substrate. Proof of purchase is required.

DISCLAIMER OF WARRANTIES AND LIMITATION OF LIABILITY: THIS LIMITED WARRANTY IS IN LIEU OF ANY OTHER WARRANTIES EXPRESS OR IMPLIED INCLUDING BUT NOT LIMITED TO ANY IMPLIED WARRANTY OF MERCHANTABILITY OR FOR A PARTICULAR PURPOSE. MANUFACTURER SHALL HAVE NO LIABILITY OF ANY KIND BEYOND PRODUCT REPLACEMENT, INCLUDING FOR CONSEQUENTIAL OR INCIDENTAL DAMAGES RESULTING FROM ANY DEFECTS OR ANY DELAYS CAUSED BY REPLACEMENT OR OTHERWISE. THIS LIMITED WARRANTY PROVIDES THE PURCHASER'S EXCLUSIVE REMEDY FOR ANY DEFECT IN THE PRODUCT.

WeatherWeld - A Division of Liquiform Technologies Inc.

9757 7th St. #803 Rancho Cucamonga, CA 91730 | (888) 440-3224 | info@weatherweld.com | (888) 440-3224

WW44444 - Base Sheet Adhesive is a premium grade, roofing adhesive. Modified, rubberized, and waterproof, it may be applied with squeegee or sprayer, and is formulated from asphalt and solvents which bond asphalt coated base sheets in various roofing applications.

PERFORMANCE

CERTIFICATIONS

PROPERTY	VALUE
Appearance:	Liquid
Color:	Black
Flash Point:	105F
Maximum VOC:	250 g/l per ASTM D 3960
Maximum VOS:	2.08 lbs/gal
Asphalt By Weight:	52 percent min.
Consistency:	Spray grade at 77F
Lap Peel Strength:	48.9 lbf/in. min. per ASTM D 3019
Solids By Weight:	75 percent per ASTM D-4479
Specific Gravity @ 77F (25C):	1.08



MORE INFO

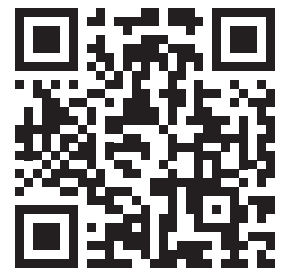

Packaging:

- 1 Gallon Cans | 10 lbs. (4.5 kg)
- 5 Gallon Pails
- 55 Gallon Drums

WeatherWeld - A Division of Liquiform Technologies Inc.

9757 7th St. #803 Rancho Cucamonga, CA 91730 | (888) 440-3224 | info@weatherweld.com

Coverage:

Apply uniformly between layers of roofing at the rate of 1 1/2 to 2 gallons per 100 sq. ft. DO NOT OVER APPLY. For spot application of the first layer to smooth, non-nailable surfaces, use 1 gallon per 100 square feet. For bonding gravel use 5 gallons per 100 square feet.

Surface Preparation:

All surfaces to be coated must be clean, dry, smooth and even. Surface must be free from oil, grease, rust, scale, loose paint, dirt, and all foreign matter that would interfere with a good bond. NOTE: A roof membrane in poor condition, moisture in the existing roof or local building codes may require tearoff of an old roof.

Application:

Stir adhesive to uniform consistency before using. Do not thin. It is suitable for spray application with most roof coating pumps and spray guns - air-atomized or airless type. The pump must be able to deliver at least 800 to 1000 psi at the spray gun tip. The tip must be .100 size with 80 deg. fan "ten-eighty" tip. The hose diameter must be at least 3/4" I.D, with the last 50' being 1/2" I.D. For hose lengths longer than 200', 1" I.D. is recommended. The product must be at least 70F (21C) at the tip for spray applications. Apply adhesive evenly and uniformly with full coverage between each layer. After adhesive is placed, a few minutes of "open time" will accelerate curing time. Roofing may usually be placed up to 1/2 hour after adhesive has been applied. While adhesive is tacky, press roofing into adhesive by brooming. Roll seams with a weighted roller several hours later. Adhesion is improved by brushing underside of sheets at laps and walls with a thin film of adhesive. Remove excess adhesive from exposed surfaces. On walls, apply adhesive to both surfaces and allow approximately 1/2 hour open time. On slopes over 1" in 12", blind nail 2nd and 3rd layer 1" down from upper edge every 12".

Cleanup:

Clean tools with kerosene, paint thinner or mineral spirits. Clean hands with waterless hand cleaner.

Warnings:

WARNING! COMBUSTIBLE! Contains petroleum distillate. Keep away from heat and flame. Do not heat container or store at temperatures greater than 110 deg. F (43C). CLOSE AIR INTAKES on roof until solvents dissipate. Contains volatile solvents that might contaminate potable water. Close container after use. DANGER! HARMFUL OR FATAL IF SWALLOWED! If swallowed, do not induce vomiting. CALL A PHYSICIAN IMMEDIATELY! Use protective measures to avoid contact with eyes and skin. In case of eye contact, open eyelids wide and flush immediately with plenty of water for at least 15 minutes. In case of accidental injection by spray equipment, GET MEDICAL ATTENTION IMMEDIATELY! USE ONLY WITH ADEQUATE VENTILATION! Avoid breathing of vapor. If you experience eye watering, headaches, or dizziness, leave area immediately or increase fresh air or wear respiratory protection (NIOSH/MSHA TC 23C or equivalent). Repeated and prolonged occupational overexposure to solvent vapor may cause permanent brain and nervous system damage, and may cause liver or kidney damage.

Warranty:

Notwithstanding its usage as a component in a No Dollar Limit (NDL) guaranteed roof system, we, the manufacturer, warrant only that this product is free of defects for a period of twelve (12) months from date of original purchase. Many factors may affect the final results obtained from this product, including but not limited to: weather, workmanship, application equipment and prior condition of the application substrate. Proof of purchase is required.

DISCLAIMER OF WARRANTIES AND LIMITATION OF LIABILITY: THIS LIMITED WARRANTY IS IN LIEU OF ANY OTHER WARRANTIES EXPRESS OR IMPLIED INCLUDING BUT NOT LIMITED TO ANY IMPLIED WARRANTY OF MERCHANTABILITY OR FOR A PARTICULAR PURPOSE. MANUFACTURER SHALL HAVE NO LIABILITY OF ANY KIND BEYOND PRODUCT REPLACEMENT, INCLUDING FOR CONSEQUENTIAL OR INCIDENTAL DAMAGES RESULTING FROM ANY DEFECTS OR ANY DELAYS CAUSED BY REPLACEMENT OR OTHERWISE. THIS LIMITED WARRANTY PROVIDES THE PURCHASER'S EXCLUSIVE REMEDY FOR ANY DEFECT IN THE PRODUCT.

WeatherWeld - A Division of Liquiform Technologies Inc.

9757 7th St. #803 Rancho Cucamonga, CA 91730 | (888) 440-3224 | info@weatherweld.com | (888) 440-3224

Warranty



40-YEAR NDL LEAK-FREE WARRANTY

COMPLETION DATE: _____

ISSUE DATE: _____

WARRANTY: Subject to warranty registration, payment in-full and installation in accordance with current printed installation specifications, Liquiform Technologies Inc., (WEATHERWELD) warranties to the original purchaser that the WEATHERWELD Seamless Reinforced Roof System (System) will be able to withstand ordinary wear of the natural elements in a leak-free condition for the period of forty (40) years, except for the exclusions, limitations and exceptions set forth in this Warranty. Upon proper notice, WEATHERWELD will diagnose and make repairs to the WEATHERWELD System at WEATHERWELD expense under the terms of this Warranty, as required to stop reported roof leakage found to be caused by defects in the WEATHERWELD System.

UNAPPROVED ALTERATIONS OR ADDITIONS: No contractor, distributor, consultant or any other person has authority to assume responsibility, liability or changes to WEATHERWELD specifications and/or agreements. WEATHERWELD shall not be responsible or liable for any change and/or amendment to the specifications and/or Warranty in regard to the project referenced herein, unless said change or amendment is approved in writing by WEATHERWELD.

EXCLUSIONS/RESPONSIBILITIES: The WEATHERWELD Seamless Reinforced Roof System is designed to keep areas to which the WEATHERWELD System materials are applied in a leak-free condition. The System is not intended to take the place of any other building element such as, but not limited to, the underlying roof deck, roof insulation, vapor retarder, drains, expansion joints, flashings, vents, skylights, roof-mounted equipment, reflective coatings, or any areas not covered with WEATHERWELD System materials. This warranty shall not be applicable if, in the sole judgment of WEATHERWELD, any of the following occurrences shall be the cause of the reported claim of WEATHERWELD System roof leakage:

- a) Natural disasters, earthquakes, lightning, hurricane force winds, hail, flood, environmental fallout, acts of vandalism or war.
- b) Acts of negligence, misuse, accidents, falling objects, damage from roof top traffic or storage on the roof.
- c) Damage caused by failure to conduct, or to have conducted, periodic maintenance inspections and roof clean-up as outlined in the NRCA or RIEI maintenance manuals for Owners. Reflective surface coatings are not required to be re-coated under this Warranty.
- d) Changes, alterations or repairs made to the System and not authorized by WEATHERWELD shall cause the area affected by the work to be excluded until authorized repairs meeting WEATHERWELD standards are completed.
- e) Changes in aesthetics, visual appearance or reflective coatings. Maintenance of coatings is not a part of, nor required, under this Warranty.
- f) With the exception of natural rain water, accumulation of foreign materials or chemicals of any type including animal, plant, human, manufacturing or atmospheric.
- g) Malfunction or breakdown of the base roofing structure.
- h) Obstructed or inadequate roof drainage.
- i) Waterproof defects in adjoining areas, walls, windows, roof-mounted equipment, ducts or other penetrations in the System extending above the flashings height of the WEATHERWELD System.

Both the examination and inspection of the WEATHERWELD System installation, plans and/or specifications by a WEATHERWELD employee, designated representative or Contractor, before or after the completion of the installation of the WEATHERWELD System, shall not constitute approval or waiver of the exclusions and conditions set forth in this Warranty, without written notice of such approval or waiver. No waiver by WEATHERWELD of any limitation, term or condition of this Warranty made as part of a warranty claim, shall operate as a waiver of any other limitation, term or condition applicable to this Warranty, on any other future claim, whether of similar or different nature. Owner agrees to provide, at Owner's expense, access to any areas requested in writing by WEATHERWELD and deemed to be relevant to the diagnosis and/or repair of the reported leak. Areas include, but are not limited to, building interior, exterior, adjoining areas and areas under roof-mounted equipment or other overburden.

NOTICE OF CLAIM: In the event leakage is discovered, the Owner shall notify WEATHERWELD within ten (10) days of the discovery via receipt-acknowledged email, writing or fax at the contact's location listed below. Any claim to which notification is not made in a timely manner, without excuse, or to which access to the roof to diagnose the cause of the leakage is not provided, shall be deemed waived. Notification shall contain information of the location and severity of the leakage, access to the leak area and the personnel to contact. Notice to the Contractor, distributor or any other person does not substitute for notice to WEATHERWELD. Address written correspondence to: Liquiform Technologies Inc., 9757 7th St. #803, Rancho Cucamonga, CA 91730. Phone (888) 440-3224

SERVICE: Upon proper notification, WEATHERWELD shall schedule a diagnosis inspection of the leakage, prepare a written report of findings and commence repair of the defects that are WEATHERWELD's responsibility under this Warranty in a timely manner, weather and schedules permitting. Should the cause of the leakage be able to be corrected during the initial service call, the Owner agrees that WEATHERWELD is hereby granted permission to make such corrections, provided there is no cost to the Owner. Should leakage documented by WEATHERWELD be caused from items that are the upkeep responsibility of the Owner under this Warranty, the Owner agrees to have repairs made to such items in a timely manner, and before requesting any additional service work made by WEATHERWELD on the leakage claim. Should WEATHERWELD repeat the process without stopping the WEATHERWELD responsible leakage, WEATHERWELD shall retain a knowledgeable outside consultant at WEATHERWELD expense to help locate the source of the leakage. WEATHERWELD and the Owner agree to complete the respective repairs made in the Consultant's report. The Owner agrees that WEATHERWELD shall have exclusive control over the diagnosis and repair to any WEATHERWELD System component found to be WEATHERWELD responsibility under this Warranty.

LIMITATIONS OF LIABILITY: This Warranty is expressly in lieu of any other guarantees and/or warranties, expressed or implied, including any implied warranty of merchantability, or fitness for a particular purpose, and any other obligation or liability on the part of WEATHERWELD whether the claim against WEATHERWELD is based upon strict liability, negligence, breach of warranty, or any other theory or cause of action. This limited Warranty contains all of the provisions of our remedies from WEATHERWELD. In no event shall WEATHERWELD be liable for consequential or incidental damages of any kind, including damages to the building or its contents. This Warranty does not cover the cost of removal and/or replacement of any other building component, roof-mounted equipment, overburden or item excluded from Warranty coverage listed above. WEATHERWELD shall be discharged of all further obligations upon the occurrence of any of the following: (a) expiration of this warranty without written renewal or transfer, (b) damage to the System from causes listed in "EXCLUSIONS/RESPONSIBILITIES" or (c) failure to comply with any other sections of this Warranty. Unresolved Warranty claims shall be settled by binding arbitration in the State of California (as exclusive venue), administered by the American Arbitration Association under its Commercial Arbitration Rules, and judgment on any award rendered by the arbitrator(s) may be entered in any court having jurisdiction thereof.

ROOF SPECIFICATION

I-1B-16-30-A

**Insulated Fluid Applied Membrane Roof System with
Title 24 Compliant Cool Roof Coating**

For New Construction or Tear-Off Applications

**Section 07 56 00
COLD FLUID APPLIED
ROOFING**

**SECTION 07 56 00
FLUID APPLIED ROOFING**

PART 1 GENERAL

1.1 SECTION INCLUDES

- A. Seamless Fluid Applied Composite Roof Systems.
- B. Roof Flashings.
- C. Roof Accessories.

1.2 RELATED SECTIONS

- A. Section 06 10 00 - Rough Carpentry.
- B. Section 07 62 00 - Sheet Metal Flashing and Trim: Cap flashing and expansion joints.
- C. Section 07 71 00 - Manufactured Roof Specialties: Counter flashing, gravel stops, fascia, scuppers, gutters, and downspouts.
- D. Section 07 72 00 - Roof Accessories.
- E. Section 22 30 00 - Plumbing Equipment: Adjacent Piping Vents and Drains.
- F. Drawings and general provisions of the Contract, including General and Supplementary Conditions and Division 01 Specification Sections, apply to this Section.

1.3 REFERENCES

- A. National Roofing Contractors Association (NRCA) Roofing and Waterproofing Manual.
- B. American Society of Civil Engineers (ASCE) - ASCE 7 - Minimum Design Loads for Buildings and Other Structures.
- C. ASTM International (ASTM):
 - 1. ASTM C 728 - Standard Specification for Perlite Thermal Insulation Board.
 - 2. ASTM D 570 - Standard Test Method for Water Absorption of Plastics.
 - 3. ASTM D 1079 - Standard Terminology Relating to Roofing, Waterproofing, and Bituminous Materials.
 - 4. ASTM D 41 - Standard Specification for Asphalt Primer Used in Roofing, Damp proofing, and Waterproofing.
 - 5. ASTM D1227 - Standard Specification for Emulsified Asphalt Used as a Protective Coating for Roofing.
 - 6. ASTM D 2523 - Standard Practice for Testing Load-Strain Properties of Roofing Membranes.
 - 7. ASTM D 3019 - Standard Specification for Lap Cement Used with Asphalt Roll Roofing, Non-Fibered, and Fibered.
 - 8. ASTM D 3909 - Standard Specification for Asphalt Roll Roofing (Glass Felt) Surfaced with Mineral Granules.

9. ASTM D 4263 - Standard Test Method for Indicating Moisture in Concrete by the Plastic Sheet Method.
 10. ASTM D 4830 - Standard Test Methods for Characterizing Thermoplastic Fabrics Used in Roofing and Waterproofing.
 11. ASTM E 108 - Standard Test Methods for Fire Tests of Roof Coverings.
 12. ASTM E 548 - Standard Guide for General Criteria Used for Evaluating Laboratory Competence.
 13. ASTM E 1980 - Standard Practice for Calculating Solar Reflectance Index of Horizontal and Low-Sloped Opaque Surfaces.
- D. Underwriters Laboratories (UL): ANSI/UL 790 - Standard Test Methods of Roof Coverings.
- E. Underwriters Laboratories (UL) - Roofing Systems and Materials Guide.
- F. CRRC - Cool Roof Rating Council.
- G. California Building Standards Code - Title 24.
- H. Sheet Metal and Air Conditioning Contractors National Association (SMACNA) - Architectural Sheet Metal Manual.

1.4 DEFINITIONS

- A. Roofing Terminology: Refer to ASTM D 1079 and glossary of NRCA's "The NRCA Roofing and Waterproofing Manual" for definition of terms related to Work in this Section.

1.5 PERFORMANCE REQUIREMENTS

- A. General: Provide watertight roofing membrane and flashing system that does not permit the passage of water, resists uplift pressures specified in this section, and is capable of withstanding thermally induced movement and exposure to weather without failure.
- B. Energy Performance:
1. Low-Slope Roofs: Provide roofing system with Solar Reflectance Index not less than 78 when calculated according to ASTM E 1980, based on testing identical products by a qualified testing agency.
 2. Roof membrane finish must comply with current California Title 24 Part 6 requirements:
 - a. Minimum three (3) year aged solar reflectance: 0.55.
 - b. Minimum Thermal Emittance: 0.75.
- C. Wind Resistance: Provide roofing membrane, base flashings and component materials that comply with requirements in FMG 4450, FMG 4470, UL 580 or UL 1897 as part of a membrane roofing system.
1. Wind Load Resistance: 1-90
- D. Fire-Test-Response Characteristics: Provide roofing materials with the fire-test-response characteristics indicated as determined by testing identical products per test method below by UL, FMG or another testing and inspecting agency acceptable to authorities having jurisdiction. Materials shall be identified with appropri-

ate markings from the applicable testing and inspecting agency.

1. Exterior Fire-Test Exposure: Class A ASTM E 108 for application and roof slopes indicated.

1.6 SUBMITTALS

- A. Submit in accordance with Section 01 30 00 - Administrative Requirements.
- B. Product Data: For each product note in this section, submit printed or digital copies of manufacturers product information including the following:
 1. Printed affirmation of performance characteristics.
 2. Roofing system design.
 3. Application Instructions.
 4. Technical Data Sheets.
 5. Material Safety Data Sheets.
- C. LEED Submittals:
 1. Product Data for Credit SS 7.2: For roof materials, indicating that roof materials comply with Solar Reflectance Index requirement.
 2. Product Data for Credit EQ 4.1: For adhesives and sealants, including printed statement of VOC content.
- D. Warranty Documents: Provide sample copies of the Manufacturer's standard form outlining the terms and conditions of the warranty specified for the Work in this section.
- E. Shop Drawings: Provide plan, elevation, section, and isometric drawings outlining waterproofing conditions at transitions, terminations, penetrations and attachments to adjacent work.
- F. Product Test Reports: Based on evaluation of comprehensive tests performed by manufacturer and witnessed by a qualified testing agency, for components of the roofing system.
- G. Research & Evaluation Reports: For components of the roofing system.
 1. Include reports from UL, ICC, FMG or another testing and inspecting agency acceptable to authorities having jurisdiction, stating entire system meets fire-test-response characteristics listed.

1.7 QUALITY ASSURANCE

- A. Installer Qualifications: Installer must be authorized by roofing system manufacturer to perform all Work specified in this section and provide an executed manufacturer's warranty.
- B. Manufacturer Qualifications: A qualified manufacturer that has UL listing for roofing system identical to that used for this project.
- C. Testing Agency Qualifications: An independent testing agency with the experience and capability to conduct the testing indicated, as documented according to ASTM E 548.

D. Source Limitations:

1. Obtain roof system components from a single manufacturer.
2. Secondary products required must be recommended and approved in writing by the roofing system Manufacturer.
3. Upon request, submit Manufacturer's written approval of secondary components in list form, signed by an authorized agent of the Manufacturer.

1.8 PRE-INSTALLATION CONFERENCE

A. Prior to commencement of Work, conduct a conference at project site. Comply with the requirements of Section 01 31 00 - Project Management and Coordination. Review and affirm methods and procedures related to the work specified in this section, including but not limited to the following:

1. Meet with owner, architect, owner's insurer if applicable, testing and inspecting agency representative, roofing installer, roofing system manufacturer's representative, deck installer, and installers whose work interfaces with or affects roofing, including installers of roof accessories and roof-mounted equipment.
2. Review methods and procedures related to roofing installation, including the manufacturer's written instructions.
3. Review and finalize construction schedule and verify availability of materials, installer's personnel, equipment, and facilities needed to make progress and avoid delays.
4. Examine deck substrate conditions and finishes for compliance with requirements, including flatness and fastening.
5. Review structural loading limitations of roof deck during and after roofing.
6. Review base flashings, special roofing details, roof drainage, roof penetrations, equipment curbs and condition of other construction that will affect roofing system.
7. Review governing regulations and requirements for insurance and certificates, if applicable.
8. Review temporary protection requirements for roofing system during and after installation.
9. Review roof observation and repair procedures after roofing installation.

1.9 DELIVERY, STORAGE, AND HANDLING

- A. Deliver materials to project site in original containers, with seals unbroken, and labeled with manufacturer's name, product brand name and type, date of manufacture, and directions for storage. For bulk-delivered materials, identify manufacturer's name and product designation with delivery receipts and material manifests.
- B. Protect roofing materials from physical damage and from deterioration due to sunlight, moisture, soiling and other sources. Comply with manufacturer's written instructions for handling, storing, and protecting during installation.
- C. Store liquid materials in their original, undamaged containers in a clean, dry, and protected location, between 50 degrees F to 80 degrees F (10 degrees to 26.7 degrees C). Ensure jobsite storage is in a shaded and well-ventilated area, away from open flame or welding sparks. Indoor Storage is recommended.

- D. Do not stockpile materials on roof without first obtaining acceptance from the Architect.
- E. Discard and legally dispose of liquid material that cannot be applied within its stated shelf life.

1.10 PROJECT CONDITIONS

- A. Weather Limitations: Proceed with installation only when existing and forecast weather conditions permit the roofing system to be installed according to manufacturer's written instructions and warranty requirements.
- B. Maintain environmental conditions (temperature, humidity, and ventilation) within limits recommended by manufacturer for optimum results. Do not install products under environmental conditions outside Manufacturer's absolute limits.
- C. The minimum temperature for application of WeatherWeld Emulsion and WeatherWeld Acrylic Coating is 50 degrees F (10 degrees C) and rising.
- D. Product application must not be performed when rain or other ambient moisture conditions such as fog or heavy dew are possible within a 72-hours of completion. Roof surface must be a minimum of 6 degrees F (3 C) above the dew point and rising.
- E. Safety Data Sheets (SDS) must be on location during the transportation, storage, and application of materials.
- F. Schedule and phase work such that new roofing materials are not subject to construction traffic. Protect new roof sections and inspect for damage upon completion.
- G. When applying materials with spray equipment, take precautions to prevent overspray and/or solvents from damaging or defacing surrounding walls, building surfaces, vehicles, or other property.
- H. The surface on which the roof system is applied shall be clean, smooth, dry, and free of projections or contaminants that could prevent proper application of or be incompatible with the new installation. Correct all sharp edges, foreign materials, oil, and grease.
- I. Take precautions to ensure that materials do not freeze.
- J. Protect completed roof sections from foot traffic for a period of at least 48 hours at 75 degrees F (24 degrees C) and 50 percent relative humidity or until fully cured.

1.11 WARRANTY

- A. No Dollar Limit (NDL) Warranty: Provide Manufacturer's written and signed No Dollar Limit (NDL) warranty document, affirming coverage in the event of a leak in the roofing membrane or base flashings applied within the scope of work outlined in this section.
 - 1. Warranty Period: Forty (40) years from date of Substantial Completion.
 - 2. Coating Warranty: Twelve (12) years from date of Substantial Completion.
- B. Project Warranty: Submit roofing installer's signed and executed warranty document affirming coverage of all work of this Section, including but not limited to insulation, cover board, fasteners, base sheet, roofing

membrane, base flashings, and walkway products.

1. Warranty Period: Two (2) years from date of Substantial Completion.

PART 2 PRODUCTS

2.1 MANUFACTURERS

A. Acceptable Manufacturer: Liquiform Technologies Inc – WeatherWeld.

1. Within 72 hours of the initial site visit, equivalent systems from The Garland Company or Tremco Roofing may be considered, providing the systems meet warranty requirements, physical characteristics and do not use solvents or fire during installation.

B. Acceptable Manufacturers:

1. Liquiform Technologies Inc – WeatherWeld.
2. _____.
3. _____.

SPECIFIER: Retain the next paragraph if Insulation is Required.

2.2 THERMAL PROTECTION

A. Insulation: Rigid polyisocyanurate board, with a fibrous glass facer meeting or exceeding the requirements of ASTM C 1289.

SPECIFIER: Enter required insulation Thickness and/or LTTR specified for this project.

1. Board Thickness: _____.
2. Long Term Thermal Resistance (LTTR value): _____.

B. Insulation Cover Board: Overlayment board with a water-resistant gypsum core and glass fiber facers embedded on both sides. Pre-primed on one side; Dens-Deck Prime Roof Board, Manufactured by GP.

SPECIFIER: Retain Thickness(es) specified for this project and delete those not required.

1. Board Thickness: 1/4 inch (6 mm).
2. Board Thickness: 1/2 inch (13 mm).

2.3 COMPOSITE MEMBRANE SYSTEM

A. General:

1. Roofing system must comply with 2007 CBC, Chapter 15.
2. Subject to compliance with requirements, provide the specified membrane configuration, applied over existing low slope roofs.

B. Basis of Design: I-1B-16-30-A, by WeatherWeld. Composite roof applied over an approved deck with CA Title

24 compliant cool roof surface coating.

1. Physical Properties:
 - a. Total Weight: 2.2 pounds per square foot (1.0 kg) dry.
 - b. Nominal Thickness: 350 mil Dry Film Thickness (DFT).
 - c. Minimum Strength: 600 psi (4136 kN/m²) per ASTM D 2370.
 - d. Minimum Elongation: 10% per ASTM D 4830.
 - e. Minimum Puncture Resistance: 700 lb. (318 kg) per ASTM D 4830.
 - f. Water Absorption: 1% max by weight per ASTM D 570.
 - g. Fire Rating: UL Class "A" assembly.
2. Membrane Configuration:
 - a. Base Sheet: Mineral surfaced cap sheet – Inverted.
 - b. Fiberglass Roving: 16 Lbs per 100 square feet.
 - c. Asphalt Emulsion: 30 gallons per 100 square feet.
 - d. CA Title 24 Cool Roof Reflective Coating: 3 Gallons per 100 square feet.

2.4 COMPOSITE MEMBRANE MATERIALS

- A. Asphalt Emulsion: WeatherWeld Asphalt Emulsion meeting or exceeding the requirements of ASTM D1227. WW471145, by WeatherWeld.
 1. VOC Content (Maximum): 0 g/l.
 2. Wet Weight: 8.7 Lbs./Gal. (1041 g/l).
 3. Dry Weight: 4.35 Lbs./Gal. (521 g/l).
 4. Solids Content by Volume: 49-53%.
- B. Fiberglass Reinforcement (Type E): Multi-end continuous fiberglass roving designed for spray operations. WWFG100, by WeatherWeld.
 1. Yield: 207 yd/lb.
 2. Tex: 2400 g/km.
 3. Spool Weight: 41.9 LB (19kg).

SPECIFIER: Select the coating required for the project based on specified design criteria. Retain only 1 of the next 2 paragraphs and coordinate the application in Paragraph 3.8

- C. Cool Roof Reflective Acrylic Coating:
 1. Basecoat: WW473049, by WeatherWeld.
 - a. Solids Content by Volume: >45-50%.
 - b. VOC Content (maximum): 400 g/l.
 - c. Weight: 7.7 - 8.7 lbs./Gal. (922 – 1041 g/l).
 2. Topcoat: CA Title 24 Cool Roof Reflective Coating as supplied by the manufacturer of the membrane system. WW472049, by WeatherWeld.
 - a. Solids Content by Volume: >45-50%.

- b. VOC Content (maximum): 400 g/l.
- c. Weight: 7.7 - 8.7 lbs./Gal. (922 – 1041 g/l).
- d. Solar Reflectance:
 - 1) Initial: 0.53.
 - 2) 3 Year Aging: 0.42.
- e. Thermal Emittance:
 - 1) Initial: 0.50.
 - 2) 3 Year Aging: 0.56.
- f. Solar Reflectance Index (SRI):
 - 1) Initial: 48.
 - 2) 3 Year Aging: 33.

2.5 SHEET MATERIALS

- A. Self-Adhering Membrane: SBS-modified membrane sheet with adhesive backing. WW474049, by Weather-Weld.
 - 1. Elongation: 85%.
 - 2. Thickness: 75 mils.
 - 3. Weight: 3 oz/ sq. yd.
 - 4. Roll Width: 36 inches.
- B. Venting Base Sheet: Asphalt coated, glass fiber reinforced base sheet meeting or exceeding the requirements of ASTM D 4601, Type II, and UL Type G2.

2.6 ADHESIVES AND SEALANTS

- A. Base Sheet Adhesive: General purpose roof adhesive meeting or exceeding the requirements of ASTM D 3019 Type III; Oly-Bond 500 Spot-Shot, manufactured by OMG.
- B. Insulation Adhesive: Two-component, low-rise polyurethane foam adhesive designed to secure insulation to roof decks; Oly-Bond 500, manufactured by OMG.
- C. Flashing Cement: Trowel grade SBS-modified flashing cement made from heavy-bodied asphalt reinforced with organic fibers.
 - 1. VOC Content (Maximum): 290 g/l.
 - 2. Weight per Gallon: 8.25 – 9.25 Lbs (988 – 1107 g/l).
- D. Polyurethane Sealant: Moisture-cured, single-component, polyurethane-based, non-sag elastomeric sealant. Meets ASTM C920, Type S, Grade NS, Class 35; Sikaflex-1A, manufactured by Sika.

2.7 SHEET METAL, FLASHING AND TRIM

- A. Metal Flashing Sheet: 24 Ga. Galvanized sheet metal flashing as specified in Division 07 Section "Sheet Metal Flashing and Trim."
- B. Flashing Boot: 24 Ga. Galvanized sheetmetal pipe boot for sealing single or multiple pipe penetrations adhered in approved adhesives as recommended and furnished by the membrane manufacturer.
- C. Vents and Breathers: Heavy gauge aluminum and fully insulated vent that allows moisture and air to escape but not enter the roof system as recommended and furnished by the membrane manufacturer.
- D. Pitch Pans: Rain Collar 24 gauge stainless or 20oz (567gram) copper. All joints must be welded or soldered to remain watertight.
- E. Drain Flashings: 4 lb (1.8kg) sheet lead formed and rolled.
- F. Plumbing stacks: 4 lb (1.8kg) sheet lead formed and rolled.
- G. Fabricated Flashings: As specified in Section 07 62 00.
 - 1. Fabricated flashings and trim must conform to the detail requirements of SMACNA "Architectural Sheet Metal Manual" and/or the CDA Copper Development Association "Copper in Architecture - Handbook" as applicable.
- H. Manufactured Roof Specialties: Manufactured copings, fascia, gravel stops, control joints, expansion joints, joint covers and related flashings and trim are specified in Section 07 71 00.
 - 1. Manufactured roof specialties must conform to the detail requirements of SMACNA "Architectural Sheet Metal Manual" and/or the NRCA "Roofing and Waterproofing Manual" as applicable.
- I. Fasteners: Factory-coated steel fasteners and metal meeting corrosion-resistance provisions in FMG 4470, designed for fastening roofing membrane components to substrate, tested by manufacturer for required pullout strength and acceptable to roofing system manufacturer.

2.8 WALKWAYS

- A. Foot Traffic Walkway Coating:
 - 1. Acrylic Coating: Fluid applied, single-component, 100% Acrylic, waterproof walking surface with ceramic granules designed to enhance the traffic resistance of the roof surface.
 - a. Coating Properties:
 - 1) Tensile Strength: 350 psi when tested in accordance with ASTM D 412.
 - 2) Elongation: 174% when tested in accordance with ASTM D 412.
 - 3) Solids Content: 95% when tested in accordance with ASTM D 2369.
 - 4) VOC: <50 g/l.
 - 5) Flash Point: 141 degrees F min. (60.6 degrees C) when tested in accordance with ASTM D 93.
 - 6) Color: Safety Yellow.

b. Granule Properties:

- 1) Specific Gravity 2.65 when tested in accordance with ASTM C 128,
- 2) Bulk Density: 90-100 lbs./Cu. Ft. when tested in accordance with ASTM C29.
- 3) Color: Yellow.

B. Walkway Pads: Mineral-granule-surfaced, reinforced asphaltic composition, slip-resisting pads, manufactured as a traffic pad for foot traffic and acceptable to roofing system manufacturer, 1/2 in (13mm). thick, minimum.

1. Pad Size: 36 inches by 60 inches (914mm x 1524mm) minimum.

2.9 ACCESSORIES

- A. General: Roofing accessories recommended by manufacturer for intended use and compatible with membrane roofing.
- B. Fasteners: Factory-coated steel fasteners and metal plates meeting corrosion-resistance provisions in FMG 4470, designed for fastening roof insulation to substrate and acceptable to roofing system manufacturer.
- C. Cant Strips: ASTM C 728 perlite insulation board.
- D. Wood Nailer Strips: Comply with requirements in Division 06 Section "Miscellaneous Carpentry."
- E. Tapered Edge Strips: ASTM C 728 perlite insulation board.
- F. Substrate Joint Tape: 6 inch (152mm) or 8 inch (203mm) wide, coated, glass-fiber joint tape.
- G. Anti-Skid Granules: Granules specifically designed for anti-skid purposes and compatible with all coatings specified in this section.

PART 3 EXECUTION

3.1 EXAMINATION

- A. Compatibility, verify all materials including existing roof are compatible.
1. Verify existing roof systems are NOT coated with silicone style coatings.
 2. Verify existing roof systems are NOT PVC single ply membrane.
 3. Verify the following for installations over lightweight insulating concrete (LWIC):
 - a. Decks must be a minimum of 2 inches (51 mm) thick with a compressive strength of no less than 125 psi (0.86 MPa) and a density of 22 pcf (352 kg/sm).
 - b. Slopes must not exceed 1 inch per foot (83 mm/m).
 - c. Membrane and insulation may not be applied directly to lightweight concrete. Mechanically attach an approved specified base sheet prior to application of subsequent insulation or membrane.

- B. Examine substrates, work areas and field conditions, for compliance with the following requirements and other conditions which may affect the performance of the roofing system. Verify the following conditions:
1. Surfaces are clean, rigid, dry, smooth, and free from cracks, holes, blisters, debris and sharp changes in elevation greater than 1/4 inch (6mm).
 2. The deck is free of depressions, waves or projections and properly sloped to drains, valleys, eaves, scuppers, or gutters.
 3. Roof openings and penetrations are adequately installed, and that roof drains are securely clamped in place.
 4. Cant strips, blocking, curbs and nailers are securely anchored and installed in accordance with manufacturers requirements.
 5. Drains and scuppers are free of ruptures and sealed on all four sides on the exterior face of walls.
 6. Surface plane flatness and fastening of roof deck complies with manufacturers requirements.
 7. Concrete curing compounds and any chemicals that may impair adhesion of roofing components have been removed.
 8. Existing roof assemblies are dry, confirmed by conducting infrared thermal scans.
 9. Verify that substrate is visibly dry and free of moisture. Test for capillary moisture by plastic sheet method in accordance with ASTM D 4263.
- C. Proceed with installation only after unsatisfactory conditions have been corrected.
- D. If substrate preparation is the responsibility of another installer, notify Architect of unsatisfactory conditions before proceeding.

3.2 PREPARATION

- A. Do not begin installation until all substrates have been properly prepared.
- B. Prior to application, clean application surfaces with water. Where wash water must be reclaimed due to contamination concentrations, roof water collection design of the building or local ordinances. Conform to local requirements for disposal of wash water.
- C. Clean substrate of dust, debris, moisture, and other substances detrimental to roofing installation in accordance with the roofing system manufacturer's written instructions.
- D. Remove or correct all sharp projections which may interfere with the integrity of the membrane.
- E. Protect roof drains and edges during construction to prevent materials from entering roof drains and conductors or migrating onto surfaces of adjacent construction. Remove roof drain plugs when no work is taking place or when rain is forecast.
- F. Protect adjacent materials and lower paving, prior to starting work, in accordance with roofing system Manufacturer's instructions.
- G. Roof Surface Preparation:
1. Vacuum loose gravel from existing roofs.

2. Remove existing perimeter edge flashings.

3.3 ROOF DECK PREPARATION

A. Metal Roof Deck:

1. Metal roof decks must be a minimum 22 gauge (0.8 mm) with a G-90 galvanized finish.
2. Prior to installation, remove any surface corrosion, oxidization, or rust. Repair or replace any panels with substantial corrosion. Fasten all loose or poorly secured decking.
3. Ensure that all panels achieve the required fastener pull-out resistance.
4. Comply with local building codes where requirements exceed those listed here.

B. Structural Concrete Roof Deck:

1. Structural concrete decks must be no less than 4" (10.2 cm) thick.
2. Decks must be smooth, level, and free from depressions or damage.
3. If deck is determined to be wet or frozen, allowed to dry prior to commencement of Work.
4. Ensure the roof deck is properly cured for no less than twenty-eight (28) days prior to commencement of the Work in this section. Confirm that all concrete additives or coatings are compatible with the specified roof system.
5. Cracks greater than 1/8" (3 mm) must be repaired with materials compatible with the membrane system specified in this section.
6. Ensure that roof drains have proper sumps, and that water drains adequately.
7. Comply with local building codes where requirements exceed those listed.

C. Plywood / Oriented Strand Board (OSB) Deck:

1. Plywood Sheathing must be a minimum 4 ply 15/32" (12 mm) thick exterior grade. Oriented Strand Board must carry a Structural 1 rating.
2. Where decking is treated with chemical preservatives or fire retardants, confirm compatibility with materials specified in this section.
3. Decking must be installed with all four sides bearing structural members. Secure to joists or cross blocking as required by local building codes.
4. Decking must remain dry during the entire application process.
5. Comply with local building codes where requirements exceed those listed.

D. Lightweight Insulating Concrete Deck:

1. Lightweight insulating concrete decks must be no less than 2" (5.1 cm) thick with a compressive strength of no less than 125 psi (87,000 kg/m²) and a minimum density of 22 pcf (352 kg/m²).
2. Do not apply the specified roof system directly to lightweight concrete decks. Over old, dry decks, additional board insulation may be solidly mopped to an approved mechanically attached anchor sheet (base sheet).

3. Comply with local building codes where requirements exceed those listed.

E. Cementitious Wood Fiber Deck:

1. Cementitious wood fiber decks must meet the minimum design loads recommended by the deck manufacturer.
2. Decks must be adequately secured for protection from both uplift pressure and lateral movement.
3. Ensure that the deck is level, without deflection, depressions, or irregularities. Replace damaged panels prior to commencement of Work.
4. A base sheet must be mechanically attached to the deck prior to installation of insulation or roofing membrane.
5. Comply with local building codes where requirements exceed those listed.

F. Gypsum

1. Gypsum decks must be smooth and free from deflections or sharp edges.
2. Fastener pull-out resistance must exceed 40 lbs. (178 N) per fastener.
3. Wet or frozen decks are not acceptable substrates to receive a roof.
4. Where the roof is installed over a new gypsum deck, avoid trapping moisture beneath the roofing system by providing underside ventilation to allow for proper curing, and include topside and perimeter venting.
5. Comply with local building codes where requirements exceed those listed.

3.4 INSULATION INSTALLATION

A. General Requirements:

1. Comply with roofing, system and insulation manufacturers' written instructions and applicable recommendations of NRCA for installing roof insulation.
2. Install and secure preformed 45 degree cant strips at transitions between roofing membrane system and vertical surfaces or angle changes greater than 45 degrees.
3. Install tapered insulation under areas of roofing to conform to slopes indicated.
4. Where indicated in the contract drawings, tapered insulation crickets must be installed to eliminate ponding water.
5. Attach insulation in accordance with the requirements of local codes as necessary to achieve the required uplift pressure resistance within the field, perimeter, and corner zones of each roof section.
6. Install one or more layers of insulation and/or cover board to achieve specified thickness. Where overall insulation thickness is 1 1/2 inch (39mm) or greater, install two or more layers, staggering joints of each succeeding layer a minimum of 6 inches (152mm) in each direction.
7. Install insulation with long edges in a continuous straight line, staggering end joints between rows, abutting edges and ends between boards. Fill gaps exceeding 1/4 inch (6mm) with insulation.
8. Cut and fit insulation within 1/4 inch (6mm) of nailers, projections, and penetrations.
9. Where necessary, taper insulation at roof drains so completed surface is flush and does not restrict

the flow of water.

SPECIFIER: Retain the following Paragraph if Insulation is to be ADHERED to the substrate

- B. Adhered Attachment:
 - 1. Adhere each layer of insulation to substrate in a cold fluid-applied adhesive approved for use by the insulation manufacturer for substrates found on this project.
 - 2. Apply adhesive in accordance with the adhesive manufacturer's recommendations, and immediately bond cover board to substrate.

SPECIFIER: Retain the following Paragraph if Insulation is to be MECHANICALLY ATTACHED to the substrate. In all cases, the top layer of insulation or cover board must be adhered.

- C. Mechanically Fastened and Adhered Attachment:
 - 1. Secure the first layer of insulation to substrates using the appropriate size and type mechanical fastener for attaching the specified roof insulation to the substrate type.
 - 2. Install subsequent layers of insulation in a cold fluid-applied adhesive.

SPECIFIER: Retain the following Paragraph if a SUBSTRATE (COVER) BOARD is required.

3.5 SUBSTRATE BOARD

- A. Placement: Loosely abut and install cover boards with long joints in continuous and straight lines, with end joints staggered between rows.
 - 1. Install with a nominal 1/4 inch (6mm) gap at vertical surfaces and a 1/8 inch (3mm) gap at board edges.
 - 2. Offset joints a minimum of 6 inches (152mm) in each direction from joints of insulation below.
- B. Attachment - Adhered: Apply adhesive to underside per adhesive Manufacturers' requirements to satisfy local building code. Immediately bond cover board to substrate.

3.6 VENTING BASE SHEET INSTALLATION

- A. Install venting base sheet with a minimum 4 inch (103mm) head lap and minimum 6 inch (152mm) side lap.
- B. Extend base sheet beyond cant strips and terminate at the top of all base flashings.
- C. Attach base sheet with adhesive or fasteners as specified by the manufacturer for each type of substrate found on the project.

3.7 ROOFING MEMBRANE INSTALLATION - GENERAL

- A. Install roofing membrane system according to roofing system manufacturer's written instructions and applicable recommendations of ARMA and NRCA.
- B. Commence installation of roofing membrane in presence of roofing system manufacturer's technical personnel.

- C. Cooperate with testing and inspecting agencies engaged or required to perform services during roofing system installation.
- D. Coordinate installation to ensure that materials that will not be permanently exposed are protected from moisture and covered at the end of each workday.
 - 1. Provide tie-offs at the end of each day's work to cover exposed roofing membrane sheets and insulation with a course of coated felt set in roofing cement with joints and edges sealed.
 - 2. Complete terminations and base flashings and provide temporary seals to prevent water from entering completed sections of roofing system.
 - 3. Remove and discard temporary seals before beginning work on adjoining roofing.
- E. Substrate Joint Penetrations: Where exceeding 1/4 inch in width (6mm), tape joints to inhibit roofing cement from penetrating substrate, entering building, or damaging roofing system components or adjacent building construction.

3.8 FLASHING INSTALLATION

- A. General:
 - 1. Refer to the manufacturer's application manual for flashing specific details.
 - 2. All flashings must have a minimum of 536 mil of fiberglass composite upon completion of the installation.
 - 3. Fabricated flashings and trim must conform to the requirements found in the current SMACNA "Architectural Sheet Metal Manual".
 - 4. Manufactured Roof Specialties: Manufactured copings, fascia, control joints, and related flashings and trim must conform to the requirements found in the SMACNA "Architectural Sheet Metal Manual" and/or the National Roofing Contractors Association "Roofing and Waterproofing Manual".
 - 5. Any joint in the structure intended to allow for movement must be divorced from the seamless reinforcement composite.
 - a. Install an 18 inch (457mm) wide slip sheet consisting of inverted (mineral-side down) cap sheet, laid dry over the joint and extending 36 inches (914mm) at each end.
 - b. Over the slip sheet, solidly adhere a 36 inch (914mm) polyester ply in 4 gallons per 100 square feet (1.63 L/m²) of emulsion and reinforce with 536 mil of seamless composite.
- B. Base Flashings and Cant Strips: Minimum 3 inch (76mm) cant strips must be installed at base flashings, walls, and curbs. Miter cants at ends to provide a smooth transition and set in adhesive.
- C. Metal Drip Edges:
 - 1. Inspect nailers for proper attachment and configuration.
 - 2. Run one ply of self-adhering membrane 2 inches (51mm) over the edge. Assure coverage of all wood nailers.
 - 3. Install continuous cleat and fasten at 6 inches (152 mm) o.c.
 - 4. Install new metal edge, securing to cleat and set in bed of roof cement. Fasten flange to wood nailers every 3 inches (76 mm) o.c. staggered.

5. Apply primer to metal edges at a rate of 100 square feet per gallon and allow to dry.
6. Adhere a continuous strip of self-adhering membrane to the metal flange 2 inches (51mm) from the edge and extend 6 inches (152mm) onto the existing roof surface.
7. Coordinate placement to ensure membrane laps do not coincide with metal laps.
8. Reinforce with 500 mil of seamless composite. Extend the field application of composite to the outside edge of the metal flashing.
9. Apply composite flush with the edge to ensure that water does not pond.

D. Roof Edge with Gutter:

1. Inspect nailers for proper attachment and configuration.
2. Install one ply of self-adhering membrane 2 inches (50mm) over the edge. Assure coverage of all wood nailers.
3. Install gutter and strapping.
4. Install continuous cleat and fasten at 6 inches (152 mm) o.c.
5. Install new metal edge, securing to cleat and set in bed of roof cement. Fasten flange to wood nailers every 3 inches (76 mm) o.c. staggered.
6. Apply primer to metal edges at a rate of 100 square feet per gallon and allow to dry.
7. Adhere a continuous strip of self-adhering membrane to the metal flange 2 inches (51mm) from the edge and extend 6 inches (152mm) onto the existing roof surface.
8. Coordinate placement to ensure membrane laps do not coincide with metal laps.
9. Reinforce with 500 mil of seamless composite. Extend the field application of composite to the outside edge of the metal flashing.
10. Apply composite flush with the edge to ensure that water does not pond.

E. Scuppers:

1. Inspect nailers for proper attachment and configuration.
2. Run one ply of self-adhering membrane 1 inch (25mm) over the edge. Assure coverage of all wood nailers.
3. Install pre-formed scupper in a 1/4 inch (6 mm) bed of roof cement. All seams and corners must be soldered, and scupper must have a minimum 4 inch (101 mm) flange. Prime scupper at a rate of 100 square feet per gallon and allow to dry.
4. Fasten scupper flange to nailers every 3 inches (76mm) o.c. staggered.
5. Adhere a continuous strip of self-adhering membrane to the metal flange approximately 2 inches (51mm) from the edge and 6 inches (152mm) onto the existing roof surface.
6. Coordinate placement to ensure membrane laps do not coincide with metal laps.
7. Reinforce with 500 mil of seamless composite. Extend the field application of composite to the outside edge of the metal flashing.
8. Apply composite flush with the edge to ensure that water does not pond.

9. scupper edge must be turned down a minimum of 1 inch (25mm) at outside edge of wall and sealed.

F. Coping Caps:

1. Attach tapered nailer to top of wall with a minimum slope of 1/4 per foot.
2. Cover nailer and all exposed wood with self-adhering membrane, extending 2 inches (50mm) over edges.
3. Reinforce with 500 mil of seamless composite. Extend field application of composite to the outside edge of wall.
4. Install continuous cleat and fasten at 6 inches (152 mm) o.c. to outside wall.
5. Install new metal coping cap hooked to continuous cleat.
6. Overlap joints a minimum of 4 inches (101 mm) and install in a 1/4 inch (6 mm) bed of polyurethane sealant.
7. Fasten inside of cap 24 inch (609 mm) o.c. with approved fasteners and neoprene washers.
8. Install 6 inch (152mm) strips of self-adhering membrane, extending 3 inches (76mm) onto each side of joint. Extend down front and back face of coping.
9. Install coping cap per manufacturer's recommendations.

G. Surface Mounted Counterflashing:

1. Set counterflashing in adhesive and fasten above flashing at 8 inches (203 mm) o.c.
2. Install sealant at top of counterflashing.

H. Recessed Counterflashing:

1. Cut receiver groove into concrete masonry unit wall located at the first horizontal grout joint above base flashing termination.
2. Secure recessed "Reglet" type counterflashing with expansion fasteners.
3. Install sealant at top of counterflashing.

I. Skirted Counterflashing:

1. Where existing counterflashing does not adequately cover finished base flashings, a "skirt flashing" may be installed.
2. Specific applications must be approved by the Manufacturer prior to application and conform with manufacturers' most current construction details for the specific application.
3. Flashing must extend at least 1 1/2 inches (39mm) behind existing counterflashing and project no greater than 3 inches (76mm) past the bottom edge. Vertical seams must overlap a minimum of 6 inches (152mm).
4. All metal edges which may come in contact the base flashing must be hemmed to protect the installed membrane.
5. Mechanically fasten skirt flashing to existing counterflashing using self-tapping screws with neoprene washers.

J. Expansion Joints:

1. Install compressible insulation in neoprene cradle.
2. Apply self-adhering membrane sheet to cover expansion joint curb and extend 9 inches (228 mm) onto the field of the roof.
3. Reinforce with 500 mil of seamless composite. Extend application of composite to the top of expansion joint curbs.
4. Install pre-manufactured expansion joint cover. Fasten sides at 12 inches (609 mm) o.c. with fasteners and neoprene washers. Furnish all joint cover laps with sealant between metal covers.

K. Area Dividers:

1. Apply self-adhering membrane sheet to cover expansion joint curb and extend 9 inches (228 mm) onto the field of the roof.
2. Reinforce with 500 mil of seamless composite. Extend application of composite to the top of area divider curbs.
3. Install pre-manufactured expansion joint cover. Fasten sides at 12 inches (609 mm) o.c. with fasteners and neoprene washers. Furnish all joint cover laps with sealant between metal covers.

L. Equipment Supports:

1. Apply self-adhering membrane sheet to cover expansion joint curb and extend 9 inches (228 mm) onto the field of the roof.
2. Reinforce with 500 mil of seamless composite. Extend application of composite to the top of the support curb.
3. Install pre-manufactured cover. Fasten sides at 24 inches (609 mm) o.c. with fasteners and neoprene washers. Furnish all joint cover laps with sealant between metal covers.
4. Set equipment on neoprene pads and fasten as required by equipment manufacturer.

M. Curbs:

1. Apply self-adhering membrane sheet to cover expansion joint curb and extend 9 inches (228 mm) onto the field of the roof.
2. Reinforce with 500 mil of seamless composite. Extend application of composite to the top of the curb.
3. Install pre-manufactured counterflashing with fasteners and neoprene washers.

N. Skylights, Smoke Vents and Roof Hatches:

1. Apply self-adhering membrane sheet to cover expansion joint curb and extend 9 inches (228 mm) onto the field of the roof.
2. Reinforce with 500 mil of seamless composite. Extend field application of composite to the top of the curb.
3. Install pre-manufactured unit in accordance with Manufacturers' recommendations.

SPECIFIER: Retain the following paragraph if OSHA Compliant Fall Protection Screens are required.

4. At all required locations, install OSHA compliant, compression mounted skylight protection screens

per skylight manufacturers' written instructions.

O. Roof Drains:

1. Prior to commencing flashing work, plug drains to prevent debris from entering plumbing.
2. Taper insulation towards drains to create a sump 24 inches (609 mm) from center of drain.
3. Apply self-adhering membrane over drain. Cut out sheet inside drain bowl.
4. Set lead or copper flashings (30 inch square minimum) in 1/4 inch bed of roof cement. Extend flashing into drain a minimum of 2 inches (50 mm), apply primer to metal at a rate of 100 square feet per gallon, and allow to dry.
5. Reinforce with 500 mil of seamless composite extending down walls of drain bowl and allow to cure.
6. Install clamping ring, remove drain plug and attach strainer.

P. Pipe Penetrations: All pipe penetrations must be flashed with a minimum 24 gauge galvanized sheet metal storm collars installed approximately 1 inch (25mm) above the top of the flashing boot and secured with a draw band with approved sealant.

Q. Heat Stacks:

1. Run roof system over the entire surface of the roof. Seal the base of the stack with sealant.
2. Prime flange of new sleeve. Install properly sized sleeves set in 1/4 inch (6 mm) bed of roof cement.
3. Reinforce with 500 mil of seamless composite.
4. Install new storm collar. Weld or install stainless steel draw band and caulk.

R. Pitch Pockets:

1. Place the pitch pocket over the penetration and prime all flanges.
2. Apply strips of self-adhering membrane around all sides of pitch pocket, extending 6 inches (152 mm) onto the field of the roof.
3. Fill pitch pocket halfway with non-shrink grout.
4. Encapsulate entire pitch pocket with 500 mil of seamless composite.
5. Caulk joint between roof system and pitch pocket with roof cement.
6. Place a water shedding bonnet over the top of the pitch pocket, clamp the top with a drawband, and apply sealant.

S. Pipe Supports: Install supports in accordance with Manufacturers' guidelines. Traffic pads must be installed under pipe supports and fasteners must not penetrate the roofing membrane.

1. All pipes 2 inches (51mm) in diameter or less may be supported with polymer pipe supports spaced no greater than 8 feet (2438mm) on center.
2. All pipes over 2 inches (51mm) in diameter must be supported with movable pipe hangers or other support system approved by the roofing system Manufacturer.

T. Moisture Vents: Install 1 way aluminum moisture vents every 1000 sq ft. Apply 500 mils of seamless com-

posite to the aluminum flange such that the seamless composite seals a minimum of 3 inches (76mm) to forms a solid continuous seal.

- U. Sloped Roof Transitions: Remove roofing material extending a minimum of 24 inches (610mm) onto steep-slope roofs.
 - 1. Install self-adhesive membrane, extending 12 inches(304mm) onto low slope roof and 24 inches (609mm) onto steep slope roof.
 - 2. Reinforce with 500 mil of seamless composite.
 - 3. Install steep slope roofing material in accordance with Roofing Manufacturer's recommendations and requirements.

SPECIFIER: Composite roofing may be applied in two passes of half the wet recommended thickness if necessary due to weather or new construction phasing.

3.9 FIELD MEMBRANE INSTALLATION

- A. Apply one layer of the composite roofing at the following ratio:
 - 1. Asphalt Emulsion (undiluted): 30 gal. per 100 square feet (12.2 l/m²).
 - 2. Fiberglass Reinforcement: 16 lb. per 100 square feet (0.78 Kg/m²).
- B. In accordance with the roofing system manufacturer's flashing details, apply seamless composite to the entire roof surface, terminating at the following locations:
 - 1. Tops of base flashings and curbs
 - 2. Outside edges of perimeter metal flashings.
 - 3. Outside edges of walls.
 - 4. Insides of drain bowls.
- C. No water or other material may be added to the emulsion to thin or extend pot life.
- D. Fiberglass must be disbursed from the applicator in varying intertwined lengths, up to 24 inches (610mm).
- E. Thoroughly mix fiberglass and emulsion prior to application on roof deck.
- F. Any loose strands must be brushed by hand, removed or filled-in with emulsion to create a solid surface.
- G. Upon completion, no area may be less than 330 mil dry film thickness (DFT).
- H. Areas such as base flashings and penetrations, where application exceeds 500 mils wet, must be brushed by hand to prevent surface crazing.
 - 1. Where required due to phasing or weather conditions, composite roofing may be applied in two passes of half the recommended wet mil thickness.

3.10 REFLECTIVE COATING INSTALLATION

- A. Prior to reflective coating application, wash the roof surface with water. Do not commence application until

the system has thoroughly dried, as registered by a reading of zero with a calibrated moisture meter.

- B. Apply specified roof coating to the entire roof surface at a minimum of 1 1/2 gal. per 100 square feet (0.6 L/m²) in each of two passes to total 3 gallons per 100 square feet. (1.2 L/m²). Back rolling is recommended to ensure even coverage throughout.

SPECIFIER: Delete if Rooftop Ducts are not specified for coating.

3.11 ROOFTOP DUCT ENCAPSULATION

- A. Rooftop sheet metal ducts may be encapsulated with the rooftop composite membrane system specified in this section, installed at 250 mil DFT.
- B. Install on top and sides of sheet metal ductwork. Do not apply membrane to the underside of ductwork, on or above mechanical units or on flexible bellows.

SPECIFIER: Delete if Walkways are not specified.

3.12 WALKWAY APPLICATION

- A. Walkway Pads:
 - 1. Install walkway pads using units of size indicated on contract drawings.
 - 2. Where not expressly specified, install manufacturer's recommended size for the location and anticipated traffic volume.
 - 3. Install walkway pads with a cold adhesive compatible with the membrane specified.
- B. Embedded Granule Traffic Surfacing:
 - 1. Immediately following the application of the field, mineral granules may be broadcast into the wet acrylic membrane in areas where traffic is likely to occur. Backroll granules with a suitable roller immediately.
 - 2. Apply granules at a rate of 20 Lbs (9 kg) per 100 square feet.

3.13 FINAL ROOF INSPECTION

- A. At completion of roofing installation and associated Work, schedule a conference to include the Architect, Contractor, roof membrane installer, installers of associated work, roofing system Manufacturers' representative and others directly concerned with performance of roofing system.
- B. Perform a site walk of roof surface, inspecting perimeter edges and flashings. Identify all items requiring correction or completion and furnish copy of list to each party in attendance.
- C. Should roof core testing verify the presence of damp or wet materials, it is the responsibility of the installer to replace the damaged areas at their expense.
- D. The repair or replacement of defective work found during inspection is required to produce an installation that is free of damage and deterioration at time of Substantial Completion and is required to execute the Manufacturer's warranty.

- E. Notify Architect upon completion of corrections.
- F. Upon a successful final inspection, the contractor will provide an executed copy of the Manufacturer's warranty and written acceptance of the installation.

3.14 PROTECTION

- A. Prior to allowing any traffic on newly installed roof membrane, authorization in writing must be obtained from the roof system Manufacturer.
- B. Provide traffic ways, and erect barriers, fences, guards, rails, enclosures, chutes, and other measures to protect personnel, roofs and structures, vehicles and utilities.
- C. Protect roofing system from damage and wear during remainder of construction period. When remaining construction will not affect or endanger roofing, inspect roof for deterioration and damage. Where any defects or damage are identified describe their nature and extent in a written report, with copies to architect and owner.
- D. Protect exposed surfaces of finished walls with tarps to prevent damage.
- E. Plywood required for material movement and traffic over existing roofs must be a nominal 5/8 inch (16 mm) thick or greater.

3.15 CLEANING

- A. Clean-up and remove daily from the site all wrappings, empty containers, paper, loose particles, and other debris resulting from these operations.
- B. Remove coating markings from finished surfaces.
- C. Repair or replace defaced or disfigured finishes caused by Work of this section.
- D. Clean overspray and spillage from adjacent construction using cleaning agents and procedures recommended by manufacturer of affected construction.

END OF SECTION